



## PRODUCT CATALOG

UPDATED 2/2025

# SOLUTIONS FOR INTEGRATION PROFESSIONALS

RESIDENTIAL | COMMERCIAL | HOSPITALITY

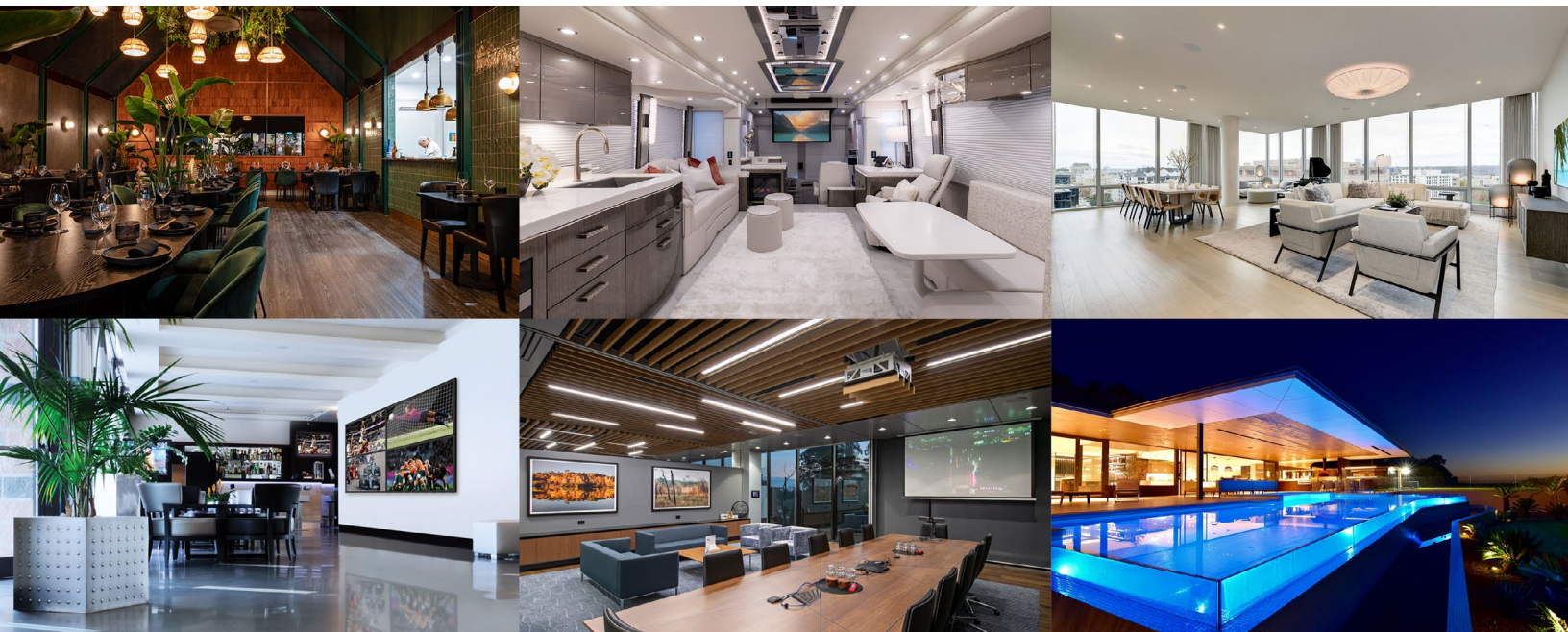

When was the last time you fell in love with a remote?





## Table of Contents

Control Processors .....	4
Intelligent Surfaces - Remotes.....	8
Intelligent Surfaces - Touchpanels.....	13
Intelligent Surfaces - Keypads .....	19
Control Apps.....	20
Custom Engraving.....	21
Audio Distribution.....	23
Video Distribution - Video over IP .....	31
Video Distribution - HDBaseT .....	33
Video Distribution - HDBaseT.....	35
Video Distribution - HDMI.....	37
Workspace Solutions .....	39
Accessories - Control Modules.....	44
Accessories - Receivers & Antennas .....	47
Accessories - Power Supplies .....	48
Accessories - Dealer Tools .....	49

## Contact Information

Remote Technologies Incorporated  
5775 12th Avenue East, Suite 180  
Shakopee, MN 55379  
www.rticontrol.com

Main - 952-253-3100 / Fax - 952-253-3131  
Sales - 952-253-3106  
Customer Service - 952-253-3136  
Technical Support - 952-253-3137

## Training

The RTIXCEL Training Portal is designed to provide custom installation professionals with training options to accommodate a busy schedule. From integration fundamentals to advanced multi-room AV programming, dealers at every experience level will learn the essential knowledge they need to succeed in today's world of automation. Whether onsite, online or a comprehensive three-day training held at the RTI headquarters, dealers have the options to take their expertise and their business to the next level. Access from the RTI dealer portal.

## Warranty

**NOTE: For complete warranty information please consult the product page on the RTI website.**

Remote Technologies Incorporated warrants its products for a period of three (3) years from the date of purchase from an authorized Remote Technologies Incorporated distributor. Rechargeable batteries and B-Stock products carry a one (1) year warranty. Warranties apply only to those products sold through authorized RTI dealers. Any product found to be defective can be exchanged at an authorized RTI distributor within 90 days of purchase. After 90 days, all products must be returned to RTI for repair, after receiving a Return Authorization from RTI Customer Service.

### Service:

RTI products not covered by warranty can be repaired for a fee by obtaining a Return Authorization number from RTI Customer Service. The Return Authorization number should be referenced on the shipping carton and a copy of the Return Authorization form should accompany the product in the shipping carton. Products returned for service may be repaired or replaced at RTI's discretion.

## Disclaimer and Copyright Information

- All rights are reserved. No part of this document may be photocopied, reproduced, or translated without the prior written notice of Remote Technologies Incorporated.
- The information contained in this document is subject to change without notice. Remote Technologies Incorporated shall not be liable for errors or omissions contained herein or for consequential damages in connection with the furnishing, performance, or use of this product reference guide.
- Windows is a registered trademark of Microsoft Corporation in the United States and other countries.
- Zigbee is a registered trademark of the Zigbee Alliance.
- Z-Wave is a registered trademark of Sigma Designs Inc.
- Apple, iPod touch, iPhone and iPad are registered trademarks of Apple Inc.
- Android and Google Play are registered trademarks of Google Inc.
- Integration Designer and the RTI logo are registered trademarks of Remote Technologies Incorporated.
- Other brands and their products are trademarks or registered trademarks of their respective holders.

## XP-8v Control Processor



The XP-8v is our most powerful system processor for control and automation of the most advanced smart homes, smart offices, and hospitality environments. XP-8v delivers maximum processing power, with an expanded number of inputs and outputs, including an HDMI® output to enable an on-screen display (OSD) interface.

Control is delivered via IP, RS-232, infrared, relays, and sensing to support the entire RTI ecosystem and connected subsystems, allowing for easy expansion using multiple processors and a complete line of accessory devices.

### Key Features

- Powerful 32bit, 1GHz CPU and 512Mb of non-volatile Flash memory.
- HDMI® output for OSD provides bidirectional control interface on a TV.
- Eight multi-purpose I/O ports for infrared and RTI modules for power sensing and one-way RS-232.
- Ethernet port allows two-way control via IP and RTIPanel support.
- Eight dedicated RS-232 ports allow bi-directional control.
- Eight programmable relays may be programmed for contact or voltage trigger.
- Eight sense inputs allow events to be triggered from either a contact closure or voltage trigger.
- Compatible with RTI ZM-24 2.4GHz Zigbee® Transceiver Module, RM-433 Antenna Module and wired user interfaces.
- USB and Ethernet programming.



**Part #: 10-210618-19**

**Included in the Box:**

XP-8v, power supply (12V, 1A), RJ45 to DB9 serial adaptor (8), rack ears (2) with screws, feet (4) with screws, terminal blocks (3x 4-position, 3x 2-position)

### Specifications

Power Supply .....	+12VDC, 1A
Multi-Purpose Output Ports .....	Eight custom 3.5mm 4-conductor jacks. Designed for RTI modules as well as industry-standard IR emitters.
IR Output Drive .....	100mA maximum (per port, adjustable) 200mA maximum (high IR output port)
Infrared Frequency Transmission Range.....	15kHz - 460kHz
Infrared Input.....	Compatible with industry-standard repeaters and receivers
Video Output for OSD.....	HDMI® 720p/1080p
Relays .....	Eight, 3 Amps @ 30 VDC or 12V/100mA Trigger
Sense Inputs.....	Eight, Digital/Closure
RS-232 Ports.....	Eight, RJ45 Connection
Ethernet Port.....	One 10/100Base-T, RJ45 Connection
USB Ports.....	Two Host, 1 Programming
RTI Com Port .....	Two-way Zigbee® Communication Port, RJ45 Connection
Expansion Port.....	One RS-485 / IR / PWR, RJ45 Connection
Memory Expansion .....	SD/MM Card Slot
Display.....	High-contrast STN LCD
Display Size (H x W) .....	0.7" x 2.8" (18 mm x 60 mm)
Backlights.....	32h x 122w pixels
Mounting .....	Blue LED (Display/Keypad)
Dimensions (W x H x D) .....	17" x 1.7" x 6.4"
Weight .....	432 mm x 43 mm x 162 mm 4 lb. (1814 g)

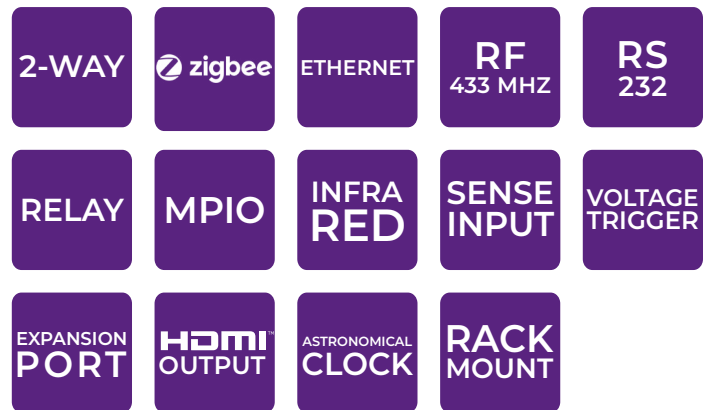

### Back Panel

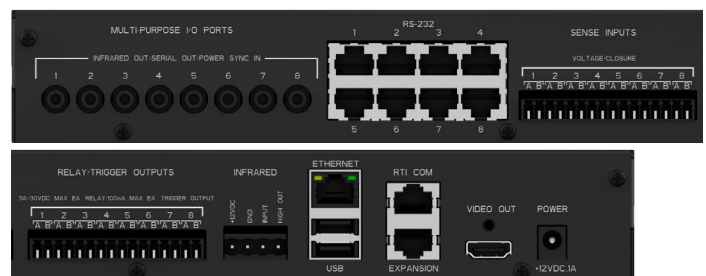



# XP-6s Control Processor



The XP-6s control processor is the perfect centerpiece of any professionally installed control and automation system.

Control is delivered via IP, RS-232, infrared, relays, and sensing to support the entire RTI ecosystem and connected subsystems, allowing for easy expansion when using multiple processors and our line of accessory devices. With a rack-mountable design, the XP-6s has the processing power to deliver exceptional performance for smart home and smart business systems.

## Key Features

- Powerful 32bit, 1GHz CPU and 512Mb of non-volatile Flash memory.
- Six multi-purpose I/O ports for infrared and RTI accessory modules for power sensing and one-way RS-232.
- Ethernet support for two-way control and RTIPanel support.
- Three programmable 12VDC trigger outputs.
- Three assignable voltage sense inputs and three programmable relay outputs.
- Three RS-232 ports for bi-directional communication.
- Built-in astronomical clock for time-based events and sleep timers.
- Compatible with all RTI wireless interfaces (when used with RTI RF antennas/Zigbee® transceivers) and wired user interfaces.
- Inputs for connection of multiple 433MHz RF receiver modules and one ZM-24 2.4GHz Transceiver.
- USB 2.0 and Ethernet programming.

Part #: 10-210621-13

**Included in the Box:**

XP-6s, power supply (12V, 1A), RJ45 to DB9 serial adaptor (3), screws & drywall anchors (4), terminal blocks (3x 4-position, 3x 2-position), rack ears (2)

## Specifications

Power Supply .....	+12V DC, 1A
IR Output Ports.....	Six 3.5mm jacks
.....Compatible with industry standard IR emitters	
IR Output Drive.....	100mA maximum (per port, adjustable)
.....	200mA maximum (high IR output port)
Infrared Frequency Transmission Range.....	15kHz - 460kHz
Infrared Input .....	Compatible with industry-standard
.....	repeaters and receivers
Trigger Outputs.....	Three, 12 VDC, 100mA max each
Relays .....	Three, 3 Amps @ 30 VDC
Sense Inputs .....	Three, 3-24VDC
RS-232 Ports .....	Three, Bi-directional RJ45 Connections
Ethernet Port .....	10/100Base-T, RJ45 Connection
USB Ports .....	One, Programming
RTI Com Port.....	Zigbee® Communication Port,
.....	RJ45 Connection
Mounting.....	Rack-mount or free standing
Dimensions (W x H x D).....	8.5" x 1.72" x 6"
.....	215.9mm x 43.7 mm x 152.4 mm
Weight .....	2 lb. (907 g)

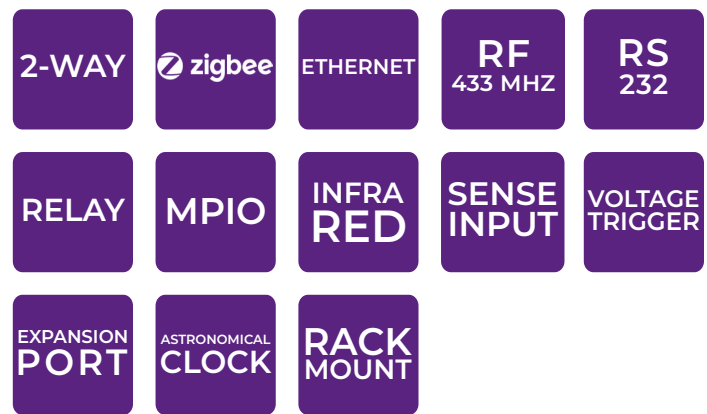

### Front Panel



### Back Panel



## XP-3 Control Processor



Part #: 10-210443-15

**Included in the Box:**

XP-3, power supply (12V, 1A), RJ45 to DB9 serial adaptor, antenna, mounting plate, screws & drywall anchors (4)

### Specifications

Power Supply .....	+12V DC, 1A or PoE (802.3af)
Wireless Networking .....	IEEE802.15.4. Zigbee® network compliant
RF Frequency Range .....	2.4Ghz - 2.5Ghz
Multi-Purpose Output Port (Port 1) .....	One custom 3.5mm. 4-conductor jack.
.....	Designed for RTI modules as well as industry-standard IR emitters.
IR Output Ports (Ports 2 & 3) .....	Two, 3.5mm jacks.
.....	Compatible with industry standard IR emitters
IR Output Drive .....	100mA maximum (per port, adjustable)
Infrared Frequency Transmission Range.....	15kHz - 460kHz
RS-232 Port.....	One, Bi-directional, RJ45 Connection
Ethernet Port.....	One, 10/100Base-T with Power-over-Ethernet (Class 3)
Relays .....	Two, 5 Amps @ 30 VDC or 12V/100mA Trigger
Sense Inputs.....	Two, 3-24VDC. Off/Low Voltage
.....	condition must not exceed 1VDC
USB Ports.....	One, Programming
Mounting .....	Wall-mount or free standing
Dimensions (W x H x D).....	7.0" x 3.0" x 1.0" (177 mm x 76 mm x 25 mm)
Weight.....	6.4 oz. (100 g)

The XP-3 is ideal for media rooms, bedrooms, meeting rooms and other small projects, delivering an exceptional level of control and automation in a small form factor. When paired with an RTI Remote, Touchpanel, or the RTI control app running on a mobile device, the XP-3 provides 2-way control for two-way real time feedback from connected 3rd party devices such as music streamers, cable boxes, lighting systems, security, and more.

Programming easily with Integration Designer, the XP-3 enables control via Ethernet, Zigbee, RS-232, IR, and relays. Its built-in astronomical clock allows for scheduling time-based events and automations.

### Key Features

- Powerful 32bit, 533MHz CPU and 128MB of non-volatile Flash memory.
- One multi-purpose I/O port and two IR output ports with variable output.
- Two assignable voltage sense inputs, and two programmable relay outputs.
- One two-way RS-232 port for 2-way communication.
- Integrated 10/100Base-T Ethernet port for programming, control and 2-way communication and supports Power over Ethernet.
- Built-in astronomical clock for time-based events and sleep timers.
- Built-in 2.4GHz ZigBee® RF transceiver module and removable antenna.

## RP-4 Control Processor



Part #: 10-210520-11

**Included in the Box:**

RP-4, power supply (12V, 1A), antenna, mounting plate, screws and drywall anchors (4)

### Specifications

Power Supply .....	+12VDC, 1A
RF Receiver Carrier Frequency .....	433 MHz
Infrared Transmission Bandwidth .....	15kHz - 460kHz
IR Output Ports .....	Four (4), 3.5mm jacks
IR Output Drive .....	100mA maximum (per port, adjustable)
Ethernet Port.....	One, RJ45 Connection, 10/100Base-T
Relays .....	Two, +30VDC, 5A max
Sense Inputs.....	Two, 3-24VDC
Mounting .....	Wall-mount or free standing
Dimensions (W x H x D).....	7.0" x 3.0" x 1.0"
.....	175 mm x 76 mm x 25 mm
.....	(Dimension does not include antenna or connectors)
Weight.....	6.7 oz. (190 g)

The RP-4 is an excellent solution for cost-effective control in single room installations such as home theaters, media centers, and bedrooms.

The RP-4 features an integrated 433-MHz RF receiver, IR control, voltage sense inputs, and relays, all in one compact package. Perfect for use with any RTI 433-MHz wireless interface, the processor also supports one-way control via the RTiPanel app, allowing users to incorporate their iPhones and iPads easily into the control system.

### Key Features

- Four infrared ports with routing and output strength adjustment.
- Infrared ports compatible with industry standard IR emitters and IR expansion devices.
- Two voltage sensing inputs for monitoring equipment power status.
- Two programmable relays provide contact closure for TV lifts, shades, projection screens etc.
- Integrated 433MHz RF antenna.
- Supports RTiPanel App for one-way control via smart phones and tablets.
- Works with all RTI 433MHz wireless remotes.
- RF signal reception and Ethernet activity LEDs.
- Install free-standing or wall mount using included mounting bracket.
- USB and Ethernet programming.

INTELLIGENT SURFACES™

# REMOTES





## ISR-4 Intelligent Surface Remote Control with WiFi and IR

### Experience unmatched entertainment and control convenience

Part #: 10-210844-20  
Included in the Box:  
ISR-4, ISR-SB charging  
base, power supply  
(5V, 2A)



When was the last time you fell in love with a remote? That time is now. Meet the ISR-4 Intelligent Surface Remote. The ISR-4 elevates every interaction, whether at home or in the executive boardroom. Its best-in-class 4" diagonal high-resolution touchscreen enables easy swiping or tapping on a fully customizable interface, while its control wheel and transport keys offer tactile convenience. With an aluminum body and luxury styling, the ISR-4 is designed for both comfort and sophistication.

### Key Features

- Flush-mount, 4.0" high-resolution capacitive LCD touchscreen (480x800).
- Wi-Fi control and program updates.
- Accelerometer provides "instant-on" control.
- Twenty assignable/programmable keypad buttons for commonly used functions.
- 2 individually illuminated programmable capacitive buttons on the touchscreen.
- Cursor button allows simple scrolling list navigation.
- Extremely wide IR transmitting frequency range.
- Non-volatile Flash memory stores your system configuration even when power is not present.

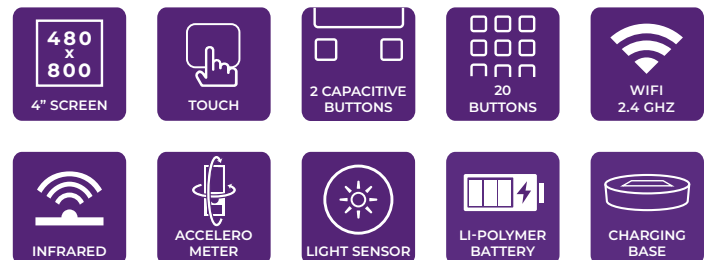

### Specifications

Power ..... 3.85 VDC, 1800 mAh Lithium-Ion Battery Pack  
 Power Management ..... Integrated accelerometer  
 Infrared Control Range .....30 feet (9.1 meters) @ 60 degrees  
 Infrared Frequency Transmission Range ..... 15kHz - 460kHz  
 Radio Frequency Control Range ..... Up to 100 feet (30.5 meters)  
 Wireless Ethernet.....802.11b/g/n @ 2.4Ghz  
 Touchscreen Display ..... High-brightness color IPS-TFT LCD.  
 ..... 480 x 800 pixels with 16.7M colors.  
 .....Integrated high-resolution capacitive touchscreen  
 Display Size ..... 4" (101mm) diagonal  
 Backlights..... White LED (keypad & soft buttons)  
 Standby Time on Full Charge.....7 Days  
 Battery Charge Time..... 3-4 Hours  
 Dimensions (L x W x D)......8.1" x 2.5" x 0.8"  
 ..... 206 mm x 65 mm x 20 mm  
 Enclosure ..... Aluminum and molded ABS plastic  
 Weight ..... 13.9 oz. (394 g) with battery pack





## ISR-2 Intelligent Surface Remote Control with WiFi and IR



Part #: 10-210838-23  
 Included in the Box:  
 ISR-2, ISR-SB charging  
 base, power supply  
 (5V, 2A)

Meet the ISR-2 Intelligent Surface Remote. Ideal for home entertainment, the ISR-2's 2.8" diagonal hi-resolution touchscreen offers intuitive swipe control on its customizable interface. With a full numeric keypad, it's perfectly suited for media control, enabling easy access to TV, movie channels, and streaming music. The ISR-2 combines sleek, modern styling with a practical layout, making it the remote you will also love for controlling lighting, climate, shades, security, and more.

### Key Features

- Flush-mount, 2.8" capacitive LCD touchscreen (240x320).
- Wi-Fi control.
- Wi-Fi control and program updates.
- Accelerometer provides "instant-on" control.
- Thirty-two assignable/programmable keypad buttons for commonly used functions.
- 2 individually illuminated programmable capacitive buttons on the touchscreen.
- Cursor button allows simple scrolling list navigation.
- Extremely wide IR transmitting frequency range.
- Non-volatile Flash memory stores your system configuration even when power is not present.

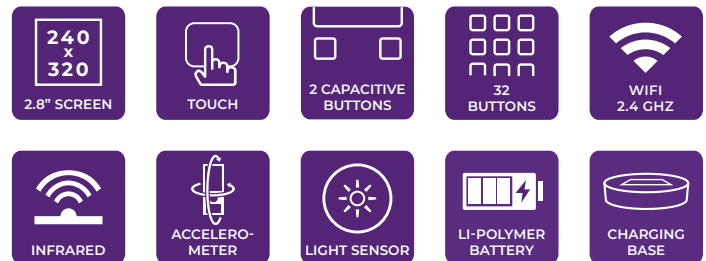

### Specifications

Power ..... 3.85 VDC, 1800 mAh Li-Polymer Battery Pack  
 Power Management ..... Integrated accelerometer  
 Infrared Control Range ..... 30 feet (9.1 meters) @ 60 degrees  
 Infrared Frequency Transmission Range ..... 15kHz - 460kHz  
 Radio Frequency Control Range ..... Up to 100 feet (30.5 meters)  
 Wireless Ethernet ..... 802.11b/g/n @ 2.4Ghz  
 Touchscreen Display ..... High-brightness color IPS-TFT LCD.  
 .....240 (RGB) x 320 pixels with 262k colors.  
 ..... Integrated high-resolution capacitive touchscreen  
 Display Size .....2.8" (71mm) diagonal  
 Backlights ..... White LED (keypad & soft buttons)  
 Standby Time on Full Charge ..... 7 Days  
 Battery Charge Time .....3-4 Hours  
 Dimensions (L x W x D) ..... 8.3" x 2.4" x 0.8"  
 ..... 212 mm x 61 mm x 20 mm  
 Enclosure ..... Aluminum and molded ABS plastic  
 Weight ..... 14.4 oz. (409 g) with battery pack



ISR-2 with ISR-SB Charging Base

ISR-AB Access Point Base  
 (sold separately)  
 Part #: 10-210839-24

## ISR-AB Access Point Base for ISR Remotes

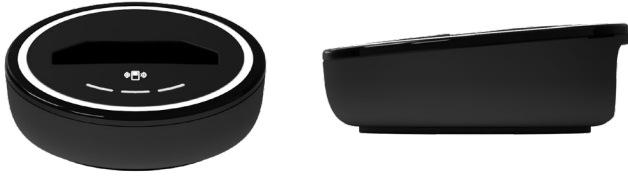

Part #: 10-210839-24

Included in the Box:

ISR-AB, international power supply (12V, 2A)

### Specifications

Power Supply .....	+5VDC, 2.0A
Ethernet .....	10/100/1000BaseT, RJ-45 Connector
PoE.....	802.3af
Wi-Fi Frequency .....	2.4GHz
Wi-Fi Modes.....	802.11ac, n, g, b, and a
Wi-Fi Range.....	Minimum of 100ft (30m) indoors
Modes of Operation.....	Hard Wired Ethernet and Wi-Fi Bridge Mode
Security .....	WPA or WPA 2 password protection
Buttons.....	Four capacitive touch, all programmable through ID11
.....	One "Find my Remote" and three programmable scenes
Button LEDs.....	One programmable indicator of "Find my Remote" icon
.....	One programmable indicator for combined scene icons
Ring LED.....	Programmable to illuminate in one of many different colors
.....	Indications for charge, acknowledgments, & more
Power for ISR Remote.....	Charging for ISR-4 or ISR-2
Battery Charge Time .....	3-4 Hours
Minimum ID Version.....	11.12 or later

What if your remote's base did more than just charge? Introducing the ISR-AB Advanced Base—the first-ever charging base to offer programmable control buttons and a "Find My Remote" button, adding unmatched convenience and elevating the control experience. The ISR-AR Advanced Base is the perfect companion to your Intelligent Surface remote, providing an instant and dedicated Wi-Fi access point for seamless and uninterrupted control.

Equipped with three programmable soft keys, it's ideal for easy control of custom scenes or frequently used room functions—without even lifting the remote off the base.

### Key Features

- Instant-Connect Wi-Fi Access. The ISR-AB creates a 2.4GHz Wi-Fi access point ensuring a fast, robust connection for the ISR remotes.
- Three programmable soft keys enable easy control for scenes and common events.
- Tap the Find-my-Remote button and the ISR Remote beeps an alert.
- Easy Charging ensures your Intelligent Surfaces Remote is always fully charged.
- Elegantly modern design.
- Adjustable Light Ring shows the charging status. Personalize both the color and the brightness.



## T1-B+ Zigbee® Remote Control

Part #: 10-210503-12

Included in the Box:

T1-B+, docking station, power supply (5V, 2A), interchangeable keycap trees (2), wall mount bracket, screws and drywall anchors (2) for wall mount bracket



### Specifications

Power .....	3.6 VDC, 950 mAh Lithium-Ion Battery Pack
Power Management .....	Automatic On/Off (tilt switch)
Infrared Control Range.....	30 feet (9.1 meters) @ 60 degrees
Infrared Frequency Transmission Range...	15kHz - 460kHz
Radio Frequency Control Range .....	Up to 100 feet
.....	(30.5 meters)
Radio Frequency Carrier.....	802.15.4 @ 2.4GHz (Zigbee®)
.....	& 433MHz
Backlight .....	White LED (Keypad)
Nominal Run Time on Full Charge .....	3 hours minimum,
.....	continuous use (7 days on average use)
Standby Time on Full Charge.....	30 Days
Battery Charge Time .....	3-4 Hours
Dimensions (L x W x D).....	10.0 in x 1.9 in x .9 in
.....	(254 mm x 48 mm x 23 mm)
Enclosure .....	High-impact molded ABS plastic
Weight.....	7 oz. (200 g) with battery pack

The T1-B+ is the third generation of RTI's popular T1 universal system controller, now featuring the RTI dual RF platform and backlit buttons. The T1-B+ allows all other factory remote controls to be combined into one simple, ergonomic user interface providing powerful one-handed system control. Featuring a sleek new industrial design and perfect assortment of keypad buttons for commonly used functions, the T1-B+ can operate today's sophisticated media system, no matter how complex, at an affordable price.

### Key Features

- Dual RF transmission capability uses 433MHz and 2.4GHz (utilizing Zigbee® technology).
- Comfortable ergonomic design permits effortless, one-handed operation.
- Tilt switch can automatically turn on the backlight when picked up.
- 8 source and 4 general purpose assignable/programmable keypad buttons with interchangeable key labels - Laser Shark compatible.
- Ships with a certificate for one Laser Shark engraved button set.
- Supports "Companion Mode" (similar to SURFiR®) for use with the RTIPanel app.
- 40 assignable/programmable keypad buttons.
- Transmits IR and RF (or both -on a single button press!).

## U3 Water Resistant Remote Control

Part #: 10-210739-23

**Included in the Box:**

U3, charging dock, cradle, mounting holster (2), lithium-ion battery (installed) (1), international power supply (5V, 1A) (1), size 10 mounting screws (4)

### Specifications

Power ..... 3.6 VDC, 900 mAh Lithium-Ion Battery Pack  
 Radio Frequency Control Range ..... Up to 100 feet  
 ..... (30.5 meters)  
 Radio Frequency Carrier.....802.15.4 @ 2.4GHz (Zigbee®)  
 ..... & 433MHz  
 Display..... Electronic Paper Display  
 Display Size..... 1.9" (48mm) diagonal  
 Battery Life .....2-3 Months on average use  
 Battery Charge Time .....3-4 Hours  
 Programming ..... 2.4GHz Zigbee  
 Dimensions (L x W x D)..... 7.9 in x 2.3 in x 1.1 in  
 ..... 201 mm x 58 mm x 28 mm  
 Enclosure .....High-impact molded ABS plastic  
 .....Removable rubber housing with anti-fungal coating  
 IP Rating ..... IP66: Dust tight and water repellent  
 Weight ..... 6.8 oz. (193 g) with battery pack



The U3 water-resistant remote is the perfect companion for hot tubs, pools, bathrooms, and decks, delivering exceptional control in environments too wet or harsh for standard remotes.

The U3 remote floats if dropped in water for easy retrieval. It uses inductive charging and wireless programming updates, allowing it to be completely sealed for exceptional (IP-66 rated) protection. The U3 combines the convenience and low power requirements of an electronic paper display with fully programmable soft-touch buttons for quick access to commonly used functions. The display is easy to read in bright light—even outdoors—and can be customized to each project via the award-winning RTI Integration Designer programming software.

### Key Features

- Durable design is weather resistant.
- Completely sealed and floats.
- Dust tight and water repellent (IP66 rated).
- Dual RF capability uses 433MHz or 2.4GHz (utilizing Zigbee® technology).
- Sixteen programmable keypad buttons.
- 1.9" electronic paper display is easy to read in bright light.
- Three different screen text size selections.
- Inductive wireless charging.
- Rechargeable Lithium-Ion battery.
- Includes charging dock and weather resistant cradle.
- Includes wall mount holsters.

## SURFiR Companion Remote Control

Part #: 10-210483-19

**Included in the Box:**

SURFiR, Alkaline AAA batteries (4), clear window, screwdriver, function label sheet, room label sheet

### Specifications

Power ..... 4 AAA Alkaline batteries  
 Power Management ..... Automatic On/Off  
 Radio Frequency Control Range ..... Up to 100 feet  
 ..... (30.5 meters)  
 Radio Frequency Carrier.....802.15.4 @ 2.4GHz (Zigbee®)  
 ..... & 433MHz  
 Standby Time ..... 365 Days  
 Dimensions (L x W x D).....9.5" x 1.8" x 0.8"  
 ..... 240 mm x 46 mm x 22 mm  
 Enclosure ..... High-impact molded ABS plastic  
 Weight ..... 8.0 oz. (228 g) with batteries



The SURFiR adds the convenience of hard buttons for tactile control to systems using Apple® or Android® devices as the main graphical interface. This eliminates the numerous screen swipes needed for control tasks that require frequent interaction such as channel changes, DVR control or volume adjustments. The SURFiR allows the user to enjoy the other benefits of their smart phone or tablet device: checking email, reading news feeds, accessing social media, etc. To further enhance the experience for the user, the SURFiR can track which electronic device is being controlled by the RTiPanel app and automatically controls the same. Powerful and intuitive control in an inexpensive package - everything you desire in a companion remote.

### Key Features

- Provides a companion remote for use with the RTiPanel and Virtual Panel apps.
- Tracks page changes to stay in sync with one or more apps.
- Dual RF transmission capability uses 433MHz and 2.4GHz (utilizing Zigbee® technology).
- Remote finder beeper allows user to easily locate SURFiR by pressing a button on their smart phone or tablet.
- Completely customizable and programmable.
- Security screw on battery door for hotel applications.
- Inexpensive and requires no direct programming.
- Includes eight buttons that can be custom labeled.
- Works with any XP series control processor
- Battery low indicator.
- Uses 4 AAA batteries.

INTELLIGENT SURFACES™

# TOUCHPANELS





# IST-10 10" Intelligent Surface Touchpanel Black



IST-10-B (Black Touchpanel)

Part #: 10-210853-20

IST-10-W (White Touchpanel)

Part #: 10-210854-21

Included in the Box:

IST-10, metal wall bracket (1), mounting bracket screws (4), single gang low voltage mounting bracket (1)

## Specifications

Power (Power Supply not included)	+12V DC, 2A
	or PoE (802.3af)
Power Management	Adjustable backlight/proximity sensor
Touchscreen Display	High-brightness 24-bit color IPS LCD
	WUXGA (1920x1200 pixels) with true black display filter
	Integrated high-resolution capacitive-touch screen
Display Size	10" (254 mm) diagonal, 16:10 aspect ratio
Display Backlight	LED Backlit, 400nit
Ethernet Port	RJ45, 10/100 Base-T with PoE
Camera	Color CMOS, 2MP, 15-30 fps at 1920x1080
Microphone	Built-in digital microphone array with
	Mute button, hardware-based echo cancellation
Speakers	Two (2), 8Ω, 1 Watt, 100-20KHz
Communications	Ethernet / Network IP
	WiFi 2.4G/5G 802.11a/b/g/n/ac
Mounting	Wall-Mount or
	Aluminum Table Stand (available separately
	as a kit including power supply)
Installation	US standard single or dual gang.
Outer Bezel Dimension (W x H x D)	9.39" x 6.24" x 0.43"
	238.5 mm x 158.5 mm x 10.9mm
Wall Cut-Out Dimension (W x H)	2.15" x 3.6"
	54.7mm x 91.5mm
Depth in Wall (Wall Box)	1.34" (34mm),
	leave space to account for the RJ-45 connector
Weight	14.1 oz (400g)

### IST Stand Kit

Material	Silver anodized aluminum, black rubber feet
Dimensions (HxL)	5.25" x 5.25" (133.4mm x 133.4mm)
Dimensions (W)	Front: 5.27" (144.8mm), Rear 2.75" (69.9mm)
Weight	14.1 oz (400g)
Power Supply for IST-10	included

The IST-10 touchpanel elevates system control in all commercial and residential settings. It starts with a hi-resolution 10" capacitive-touch screen with a 1920x1200 resolution with true-black display filter for exceptional clarity. With an ultra-thin bezel and a near-flush mount (just 0.47"/ 12mm off the wall), the IST-10 makes an elegant statement in landscape or portrait mount, while the optional stand enables tabletop and countertop convenience. Built-in 10/100 Base-T Ethernet with PoE enables seamless two-way system control, video, and remote programming.

The hi-res display is ideal for the 100% customizable RTI user interface, with fast response and easy swiping. The proximity sensor enables a fast hands-free wake while the ambient light sensors automatically adjust display brightness. The IST-10 plays hi-resolution video in H.264 or H.265 format and is ideal for viewing security camera feeds. Dual speakers, far-field microphone array, SIP-readiness, plus full duplex capability make the IST-10 perfect for intercom and as an interface with video doorbells. The hi-res 2MP camera can double as a surveillance source, while its manual shutter ensures privacy. The 2-mic array features a mute button plus hardware-based echo cancellation.

## Key Features

- Hi-resolution 10" capacitive-touch screen (1920x1200) with ultra-thin bezel.
- Near-flush mount (just 0.47"/ 12mm off the wall).
- Ethernet and Wi-Fi options for control and communication.
- PoE or 12V DC power options.
- Exceptional video streaming and two-way intercom at H.264 or H.265 format.
- Hi-res privacy ensured 2MP camera.
- Dual speakers and far-field microphone array (with mute button).
- Proximity and ambient light sensors.
- Tabletop stand option.
- Portrait or landscape with auto-rotate.



IST Stand Kit (Table Stand)  
(sold separately)  
Part #: 10-210856-23

## IST-5 5" Intelligent Surface Touchpanel Black



The new IST-5 touchpanel elevates system control in all commercial and residential settings. It starts with a hi-resolution 5" capacitive-touch screen with a 854x480 resolution with true-black display filter for exceptional clarity. With an ultra-thin bezel, near-flush mount (just 0.47"/ 12mm off the wall), and elegantly compact form-factor, the IST-5 makes an elegant statement in landscape or portrait mount. Built-in 10/100 Base-T Ethernet with PoE enables seamless two-way system control, video, and remote programming.

The hi-res display is perfect for the 100% customizable RTI user interface, with fast response and easy swiping. The proximity sensor enables a fast hands-free wake while the ambient light sensors automatically adjust display brightness. The IST-5 plays hi-resolution video in H.264 or H.265 format and is ideal for viewing security camera feeds. Dual speakers, far-field microphone array, SIP-readiness, plus full duplex capability make the IST-5 perfect for intercom and as an interface with video doorbells. The 2-mic array features a mute button plus hardware-based echo cancellation.

### Key Features

- Hi-resolution 5" capacitive-touch screen (854x480) with ultra-thin bezel.
- Near-flush mount (just 0.47"/ 12mm off the wall).
- Ethernet and Wi-Fi options for control and communication.
- PoE or 12V DC power options.
- Exceptional video streaming and two-way intercom at H.264 or H.265 format.
- Dual speakers and far-field microphone array (with mute button).
- Proximity and ambient light sensors.
- Portrait or landscape with auto-rotate.

#### IST-5-B (Black Touchpanel)

Part #: 10-210851-18

#### IST-5-W (White Touchpanel)

Part #: 10-210852-19

#### Included in the Box:

IST-5, metal wall bracket (1), mounting bracket screws (2), single gang low voltage mounting bracket (1)

### Specifications

Power (Power Supply not included) .....	+12V DC, 2A
.....	or PoE (802.3af)
Power Management .....	Adjustable backlight/ proximity sensor
Touchscreen Display .....	High-brightness 24-bit color IPS LCD
.....	FWVGA (854x480 pixels) with true black display filter
.....	Integrated high-resolution capacitive-touch screen
Display Size .....	5" (127 mm) diagonal, 16:10 aspect ratio
Display Backlight.....	LED Backlit, 400nit
Ethernet Port.....	RJ45, 10/100 Base-T with PoE
Microphone .....	Built-in digital microphone array with
.....	Mute button, hardware-based echo cancellation
Speakers.....	Two (2), 8Ω, 1 Watt, 100-20KHz
Communications.....	Ethernet / Network IP
.....	WiFi 2.4G/5G 802.11a/b/g/n/ac
Mounting.....	Wall-Mount
Installation .....	US standard single gang
Outer Bezel Dimension (W x H x D).....	5.24" x 3.33" x 0.43"
.....	133 mm x 84.5 mm x 10.9mm
Wall Cut-Out Dimension (W x H).....	2.15" x 3.6"
.....	54.7mm x 91.5mm
Depth in Wall (Wall Box).....	1.34" (34mm)
.....	leave space to account for the RJ-45 connector
Weight .....	7.05 oz (200g)

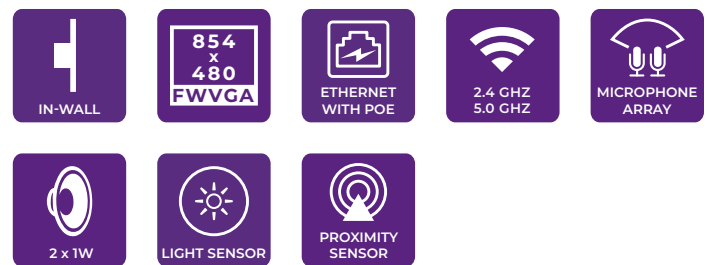

## IST-10-FMK IST-10 Flush Mount Kit

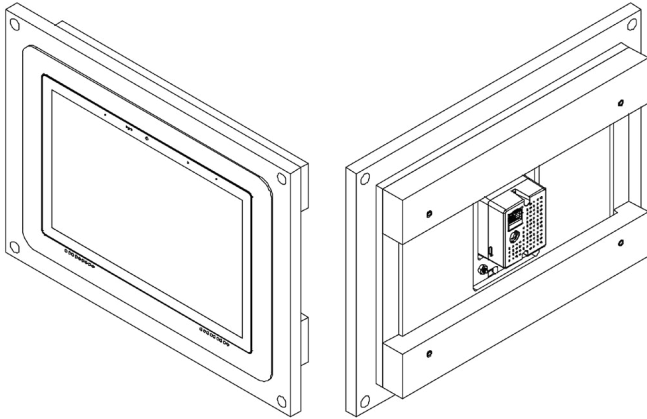

IST-5-FMK is an adapter for in-wall flush installation of an RTI IST-5 Touchpanel. IST-5-FMK firmly mounts the IST-5 touchpanel while allowing easy access, insertion and operation.

### Key Features

- Flush with the wall.
- Paintable with the wall paint in any color and texture.
- Includes depth calibration mechanism.
- Allows easy insertion and removal of the touch screen.
- The adapter is supplied unpainted (To be painted after installation as part of the wall).
- Designed to be installed in ½" drywall.

Part #: 10-210880-20

**Included in the Box:**

IST-5-FMK Flush Mount Kit, M3x12 Flat screws (2), M3 nuts (2), Touchpanel adapter

### Specifications

Material ..... Moisture resistant MDF (compliant with TSCA Title VI)  
 Installation ..... ½" drywall  
 Dimensions WxHxD ..... 6.3" (160mm) / 8.3" (210.8mm) / 1.73" (44mm)  
 Weight ..... 1.32 lb (600g)

## IST-5-FMK IST-5 Flush Mount Kit

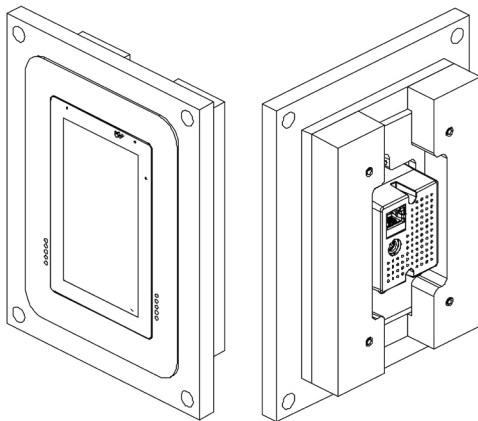

IST-10-FMK is an adapter for in-wall flush installation of an RTI IST-10 Touchpanel. IST-10-FMK firmly mounts the IST-10 touchpanel while allowing easy access, insertion and operation.

### Key Features

- Flush with the wall.
- Paintable with the wall paint in any color and texture.
- Includes depth calibration mechanism.
- Allows easy insertion and removal of the touch screen.
- The adapter is supplied unpainted (To be painted after installation as part of the wall).
- Designed to be installed in ½" drywall.

Part #: 10-210879-28

**Included in the Box:**

IST-10-FMK Flush Mount Kit, M4x12 Flat screws (4), M4 nuts (4), Touchpanel adapter

### Specifications

Material ..... Moisture resistant MDF (compliant with TSCA Title VI)  
 Installation ..... ½" drywall  
 Dimensions WxHxD ..... 12.80" (325.1mm) / 9.45" (240mm) / 1.73" (44mm)  
 Weight ..... 1.54 lb (700g)

## CX-7 7" Countertop/Under Cabinet Touchpanel



Screen Tilt - 90°



Screen Tilt - 10°



Tabletop Installation



Under Cabinet Mount (Inverted)

Part #: 10-210512-12

Included in the Box:

CX7, power supply (12V, 2A), rotatable RTI logo (1), mounting bracket (1), ferrite clamp

### Specifications

Power .....	+9VDC to +16VDC, 1A max or PoE (802.3af)
Power Management .....	Adjustable backlight brightness/proximity sensor
Touchscreen Display .....	High-brightness color TFT LCD WVGA (800x480 pixels) with 65K colors
Display Size .....	Integrated high-resolution capacitive touchscreen 7.0 in (177mm) diagonal
Display Backlight .....	Dual CCFL, 300nit
Infrared Output .....	Through control port, 200mA output Drives up to 1000 ft (300 m) of wire
Ethernet Port .....	10/100 Base-T with Power-over-Ethernet
Wireless Ethernet .....	802.11b/g
Video Input .....	Three, BNC Connectors Composite, S-Video or Component Analog Video NTSC/PAL/SECAM
Enclosure .....	High-impact molded ABS plastic
Mounting .....	Tabletop, or screws through mounting bracket (Included)
Dimensions (LxWxH) .....	7.5 in x 7.3 in x 6.25 in 190 mm x 185 mm x 159 mm
Weight .....	2.0lbs (907g)

From the kitchen countertop to the conference room, the versatile CX7 is perfect wherever intuitive “always on” control is required. The 7” LCD touchpanel has adjustable tilt, allowing the display to be angled from straight up to nearly flat. The CX7 can be mounted inverted under a cabinet, ideal for kitchens. Additional features include wired and wireless Ethernet for two-way control, digital video (MJPEG), and web browsing. Analog audio/video inputs and stereo speakers allow video viewing sources, from security cameras to satellite TV. The integrated camera, microphone and speakers enable intercom support.

### Key Features

- 800x480 WVGA LCD with integrated multi-touch capacitive touchscreen.
- Composite, S-video and component input for viewing video at 480i, 576i, 480p or 576p.
- Built-in camera, microphone and speakers enable intercom capability
- Integrated 10/100 Base-T and 802.11 Wireless Ethernet.
- Built-in high output IR port for direct control of devices through an IR connecting block.
- Powered using power supply or PoE (Power over Ethernet)
- Optional modules/processors provide advanced two-way control of electronics such as media servers, lighting, security and more!
- Adjustable tilt display (from 10°-90°) or CX7 can be mounted inverted under a cabinet.

<b>TABLE TOP</b>	<b>7"</b> 800x480	<b>2-WAY</b>	<b>ETHERNET</b>	<b>PoE</b>
<b>WIFI</b> 2.4 GHZ	<b>CAM   MIC</b> SPEAKER	<b>INFRA RED</b>	<b>VIDEO INPUT</b>	<b>AUDIO INPUT</b>
<b>PROXIMITY SENSOR</b>	<b>LIGHT SENSOR</b>			



## KX4 4" In-Wall Touchpanel Keypad w/ Control Processor



**KX4 Touchpanel (White Bezel included)**

Part #: 10-210811-14

**BZB-KX4BL (Black Bezel)**

Part #: 10-210834-19

**BB-KX3/KX4 Backbox**

Part #: 10-210560-15

**Included in the KX4 Box:**

KX4, white bezel, RJ45 to DB9 serial adapter (2), mounting wings (2), drywall template, screws (4)

### Specifications

Power .....+12VDC to +16VDC, 1A max  
 Power Management .....Adjustable backlight  
 ..... brightness/proximity sensor  
 Touchscreen Display ..... High-brightness color TFT LCD  
 ..... WVGA (480x800 pixels) with 16.7M colors  
 ..... Integrated high-resolution capacitive touch screen  
 Display Size .....4.0 in (97.2 mm) diagonal  
 Display Backlight.....LED Backlit, 310 nit  
 Button Backlight..... Blue LEDs  
 Infrared Output .....One, through control port, 200mA output  
 ..... Drives up to 1000 ft (300 m) of wire  
 Serial Port ..... Two, RJ-45, RS-232 communication  
 Ethernet Port ..... RJ-45, 10/100 Base-T with Power-over-Ethernet  
 Relays ..... Four, 2 Amps @ 30 VDC  
 Sense Inputs ..... Six, 2-24VDC  
 RF Control Range ..... Up to 100 ft (30.5m)  
 RF Carrier ..... 802.15.4 @ 2.4GHz (Zigbee®)  
 Microphone ..... Silicon MEMS  
 Speaker ..... One (1) 2 Watt, 8 Ohm  
 Enclosure ..... High-impact molded ABS plastic  
 Front Plate ..... High-impact molded ABS plastic  
 Mounting... Integrated mounting wings, or screws through front plate  
 Installation Cut-Out (W x H) .....2.942" x 5.192" (74.7 mm x 131.8 mm)  
 Outer Bezel Dimension (W x H)..... 4.352" x 5.876"  
 ..... (110.5 mm x 149.25 mm)  
 Total Depth in Wall ..... 1.265" (32.1mm)  
 .....with mounting wings 1.624" (41.2mm)  
 ..... Additional room may be necessary depending on connections used  
 Weight .....8.9 oz (252 g)

Ideal for single room commercial applications such as meeting rooms, classrooms, and lecture halls, the KX4 combines an in-wall touchpanel and hard button input with a built-in control processor. The result is an enhanced automation solution that combines control simplicity with power in a single cost-effective unit. For front panel control, the KX4 boasts a 4" high-resolution capacitive touch display with five configurable hard-buttons that can be customized with RTI's Laser Shark engraving.

The built-in control processor features advanced capabilities, including support for two-way drivers, RTiPanel App and expansion configurations. Back panel connections enable direct control of devices via IR, IP and two RS-232, six voltage sense ports with sense-event capabilities, and four relays for control via contact closure.

### Key Features

- Vivid 4" WVGA (480x800) color capacitive touchscreen, and five hard buttons provide an incredibly simple and intuitive control experience.
- Built-in control processor features advanced capabilities including support for two-way drivers, RTiPanel App and expansion capabilities.
- Control processor also enables direct control of devices via IR, IP and two RS-232, six voltage sense ports with sense-event capabilities, four relays for control via contact closure and an astronomical clock for time-based events.
- Built-in 2.4GHz ZigBee® RF transceiver module and antenna enables wireless remote control support.
- Integrated 10/100 Base-T Ethernet (with PoE) for access to network security cameras, programming updates and more.
- Proximity sensor wakes up the unit as a user approaches and an ambient light sensor adjusts the touchpanel's backlighting.
- Powered using power supply, CB8 connecting block or PoE (Power over Ethernet).
- Stylish low-profile faceplate available in white or black (ships with white).



## KX2 2" In-Wall Touchpanel Keypad

**KX2 Touchpanel (White Bezel included)**

Part #: 10-210486-22

**BZLA-KX2 (Light Almond Bezel)**

Part #: 10-210526-17

**BZB-KX2 (Black Bezel)**

Part #: 10-210524-15

**PBZBR-KX2 (Brushed Aluminum Bezel)**

Part #: 10-210525-16

**Included in the KX2 Box:**

KX2, Bezel (white), interchangeable key set (12 keys), mounting wings (2), screws (4), drywall cut-out template



### Specifications

Power .....	+9VDC to +16VDC, 1A max
Power Management .....	Adjustable backlight brightness.
.....	Ambient light sensor, proximity sensor
Touchscreen Display .....	High-brightness color TFT LCD
.....	QVGA (240w x 320h pixels) with 65K colors
.....	Integrated high-resolution resistive touchscreen
Display Size .....	2.8" (71mm) diagonal
Display Backlight .....	LED Backlit, 200nit
Infrared Output .....	Through control port, 200mA output
.....	Drives up to 1000 ft (300 m) of wire
Ethernet Port .....	10/100 Base-T with Power-over-Ethernet
Audio .....	Beeper
Enclosure .....	High-impact molded ABS plastic
Mounting .....	Integrated mounting wings, or screws through front bezel
Front Plate Dimensions (H x W) .....	4.4" x 4.6" (112mm x 117mm)
Installation Cut-Out (H x W) .....	3.789" x 3.789" (96.5mm x 96.5mm)
Total Depth in Wall .....	1.2 in (31mm) plus cables
Weight .....	7.5 oz (212g)

The KX2 in-wall controller has a clean, sleek design with twelve programmable hard buttons and a 2.8" color touchscreen. The hard buttons and graphic interface are fully programmable using RTI's Integration Designer® software for full control of electronics throughout the building. A built-in infrared output port allows direct control or get two-way control when used with an RTI XP series control processor. In addition, the unit's integrated 10/100Base-T Ethernet port with Power-over-Ethernet (POE) provides the flexibility to accommodate any installation.

### Key Features

- Fully customizable 2.8" touchscreen display and twelve assignable/programmable buttons.
- QVGA resolution (240w x 320h) TFT LCD to display custom buttons, text and graphics.
- Integrated 10/100Base-T Ethernet port with Power-over-Ethernet.
- IR output drives up to 1000 feet of wire.
- Proximity sensor automatically wakes the unit up when approached by the user and an ambient light sensor adjusts the brightness.
- Integrated mounting wings for easy installation in retrofit installs.
- Fits in a 4"x4" square electrical junction box (See important information reverse side of this page).\*\*
- Ships with stylish, low-profile white bezel - bezels also available in black, light almond and brushed aluminum.

## RKM-1+ In-Wall Audio Distribution Keypad

Part #: 10-210492-19

**Included in the Box:**

RKM-1+ (white), additional keypad cover, keycap set, mute & power buttons (1 each - black & light almond), window film (1 clear, 1 transparent purple), label sheet, screws (2)



RKM-1+ with Decora® style wall plate (not included)

### Specifications

Power .....	+9VDC to +16VDC, 350mA max
Backlights .....	Blue LED - Eight sources
.....	Blue LED - Nine volume level indicators
Infrared Output Port .....	200mA output
.....	Drives up to 1000 ft (300 m) of wire
Enclosure .....	Formed Steel, black powder coat
Front Plate .....	High-impact molded ABS plastic -
.....	White, metallic gray or black
Mounting .....	Mounts into single-gang box
Wallplate Dimensions (H x W) .....	Purchased separately (Decora® Type)
Dimensions (H x W x D) .....	4.1" x 1.8" x 1.0" (104 mm x 46 mm x 25 mm)
Installation Cut-Out (H x W) .....	2.8" x 1.8" (71 mm x 46 mm)
Total Depth in Wall .....	0.75 in (19mm) plus Cables
Weight .....	4 oz (113 g)

The RKM-1+ is a simple, intuitive keypad designed for multi-room audio control. Eight fully-programmable hard buttons and an open architecture provide the flexibility to control almost any multi-zone receiver or distributed audio system. The RKM-1+ incorporates a customizable LED backlit film which provides two-way feedback of power status, selected source, and volume level when used along with RTI XP processors and supported distributed audio systems. Sized for a single gang electrical box, the RKM-1+ is perfect for flush-mount installations in walls or cabinets and ships with white, black and light almond faceplate and buttons.

### Key Features

- Provides feedback from multi-zone receivers via RTI XP control processors.
- Use any standard Decora® type wallplate\*.
- Ships with white, black and light almond faceplate and buttons.
- Eight selectable sources.
- Backlit volume level indicator.
- Open architecture allows control of virtually any audio/video component.
- Non-volatile Flash memory stores your system configuration even when power is lost.
- IR output port drives up to 1000 feet of wire for standalone control.
- Fits in single gang electrical box.

\* Wallplate not included.

Decora® is a registered trademark of Leviton Manufacturing Co. Inc.

## KP-2 / KP-4 / KP-8 2/4/8 Button In-Wall PoE Keypad Controller



KP-2 / KP-4 / KP-8 with Decora® style wall plate (not included)



KP-2 / KP-4 / KP-8 with black or white faceplate and keycaps (included)

**KP-2 2-Button Keypad**

Part #: 10-210523-14

**KP-4 4-Button Keypad**

Part #: 10-210849-25

**KP-8 8-Button Keypad**

Part #: 10-210850-17

**Included in the KP Box:**

KP-2, KP-4, or KP-8 in-wall keypad controller, black and white faceplates (2), black and white keycap sets (2), certificate for one Laser Shark engraved keycap set (1), captive screws (2)



The KP keypad is the perfect addition to an RTI control system for fast and convenient control of music, lights, shades, and other devices or systems. Available with two, four, or eight fully programmable buttons, the KP keypad provides intuitive two-way feedback via configurable backlight colors for each button.

KP keypads ship with two sets of keypad faceplates and matching keycaps — one white and one black. For an elevated look and control experience, use RTI’s Laser Shark® engraving service to personalize the keycaps with custom text and graphics. These are available in White and Satin Black.

Compatible with Decora® style wall plates and sized to fit in a single gang US box, the KP keypads seamlessly integrate into homes and commercial buildings with a clean, intuitive on-wall control solution to match any decor.

For installation convenience, KP keypads are PoE powered, using the same network cable that runs control communication with the RTI processor.

### Key Features

- Two, four or eight assignable/programmable buttons.
- FREE Laser Engraving for custom text and graphics. A certificate for one free Laser Shark™ engraved keycap set included with purchase.
- Control communication and power over Ethernet (PoE).
- Ships with white keypad faceplate and keycap set, and a black keypad faceplate and keypad set.
- Backlight color is programmable on each button (16 colors available).
- Completely customizable and programmable.
- Fits in a single gang electrical outlet box.
- Network or USB Programming.
- Use any standard Decora® type wallplate (not included).

\* Wallplate not included.

Decora® is a registered trademark of Leviton Manufacturing Co. Inc.

### Specifications

Power .....	PoE IEEE802.3af
Backlights.....	RGB LED - 16 programmable colors
Control Port .....	10/100 BaseT with Power over Ethernet
System Memory .....	512K Bytes Flash (non-volatile) memory
Macro Capability .....	Macro capability on every button
Communications.....	USB Type C programming port
Enclosure .....	Formed Steel, black powder coat
Front Plate .....	High-impact molded ABS plastic
Mounting.....	US standard single-gang box
Decora® Type Front Plate* Dimensions (H x W) .....	4.6" x 2.75"
.....	(117 mm x 70 mm)
Dimensions (H x W x D).....	4.1" x 1.8" x 1.7"
.....	104 mm x 46 mm x 43 mm
Installation Cut-Out (H x W) .....	2.8" x 1.8"
.....	71 mm x 46 mm
Total Depth in Wall .....	1.37" (34mm) plus Cables
Operating Temperature .....	+32°F to +122°F (0°C to +50°C)
Operating Humidity.....	5% to 95% Non-condensing
Weight .....	4 oz (113 g)

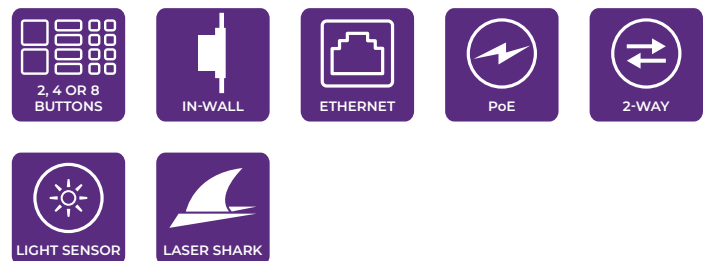

## RTiPanel App Apple/Android/Windows PC



### XP Processor Licenses for Apple® iOS/Android® /Windows® Devices

XP Single User Paper License      XP Single User e-License  
Part #: 10-210624-16                  Part #: 10-210628-20

XP Unlimited User Paper License      XP Unlimited User e-License  
Part #: 10-210625-17                  Part #: 10-210629-21

### RP-4 Processor Licenses for Apple® iPad/iPhone/iPod Touch

RP4 Single User Paper License      RP4 Single User e-License  
Part#: 10-210539-21                  Part#: 10-210536-18

RP4 5-User Paper License              RP4 5-User e-License  
Part#: 10-210546-19                  Part#: 10-210538-20

### General

- RTI XP series control processor (two-way control) or RP4 control processor (one-way control).
- The device running the RTiPanel App and the control processor must be connected to the Ethernet network.
- Remote access requires a connection to the Internet and either a static IP address from the ISP (Internet Service Provider), or a dynamic DNS account implemented.
- Two-way control and off-site access requires an XP series control processor.

### Apple iOS Devices

- RTiPanel App compatible with Apple iPad and iPhone.
- Apple devices require iOS 3.2 or higher

### Android Devices

- Requires an XP series control processor (not compatible with RP-4).
- RTiPanel App compatible with Android smart phone and tablet devices.
- Android devices with touchscreen displays larger than 5.5" will require a tablet license.
- Android devices require 2.1 or higher

### Microsoft Windows PCs

- IBM or compatible personal computer running Microsoft Windows 7, Windows 8 or higher operating system.
- At least 256 Megabytes (MB) of RAM.
- 16 bit color monitor (16 bit color 1024x768 or better recommended, 256 colors not supported).

Fully customizable using the RTI Integration Designer programming software, the RTiPanel offers the same intuitive control experience RTI remote controls offer, running on an Apple or Android smart phone or tablet device as well as on a Windows® PC. Providing secure local or remote access to an RTI control processor from any Internet connection, the RTiPanel allows for control via LAN, Wi-Fi and WAN control off site. When used with an XP series control processor, users can view and adjust thermostats, monitor security systems and turn off lights, in addition to controlling their A/V electronics, from the office, on vacation, or virtually anywhere in between. The RTiPanel app is also available for local, one-way control using the RP-4 control processor.

### Key Features

- Control and receive feedback from audio, video, lighting, security, climate, and more!
- RTiPanel app available through Apple App Store®, Google Play® and the Amazon App Store®
- Fully integrate Apple iPad®, iPhone®, iPod Touch®, Android™ devices and Windows® PCs into RTI control systems utilizing an XP series and RP-4 control processor.
- Completely customizable graphical interface.
- Supports creation of both portrait and landscape views with minimal extra programming required.
- RTiPanel supports full two-way feedback, including cover art, graphics, text, dynamic scrolling lists, and more (Requires XP processor).
- Supports local connection via LAN, and off-site access via WiFi or cellular data (if available), with automatic switching.
- Highly optimized for fast connection times.
- Control system programming stored on Apple/Android/Windows devices and updates automatically when changes are made.

### Available at



Android is a trademark of Google Inc.

Apple iPad, iPhone, iPod Touch and Apple App Store are registered trademarks of Apple Inc.

### Notes

- The RTiPanel App can be downloaded for free, however, licensing and programming fees will apply. Please contact an RTI dealer for further information.
- Features and system requirements subject to change without notice.



## Laser Shark® Custom Button Engraving



**Laser Shark Paper Certificate**  
Part #: 10-210478-23

**Laser Shark eCertificate**  
Part #: 10-210487-23

### Laser Shark Software

The Laser Shark® Software is available on the dealer section of the RTI website:

<https://www.rticontrol.com/dealer/software/custom-engraving>

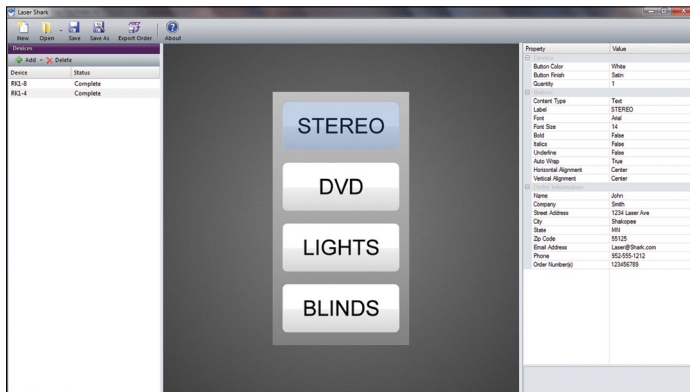

### Instructions

<https://www.rticontrol.com/pub/media/wysiwyg/dealer/technote/RTI-Laser-Shark-Custom-Engraving-Quick-Tips.pdf>

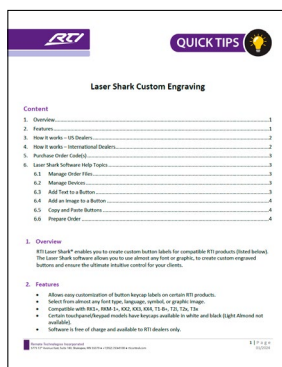

RTI Laser Shark® enables you to create custom button labels for compatible RTI products (listed below). The Laser Shark software allows you to use almost any font or graphic, to create custom engraved buttons.

### Key Features

- Allows easy customization of button keycap labels on certain RTI products.
- Select the font type, language, symbol or graphic image.
- Compatible with KP-2/4/8, RKM-1+, KX2, KX4, T1-B+, T2i, T2x.
- Certain touchpanel/keypad models have keycaps available in white and black (Light Almond not available).
- Software is free of charge and available to RTI dealers only.

### Laser Shark® Compatible Devices

RKM-1+

interchangeable source indicator lens.



KP-2, KP-4, KP-8

all buttons

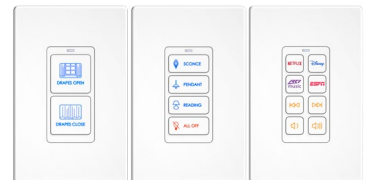

KX2

all twelve hard button keycaps



KX4

all five hard button keycaps (order includes 10 button keycaps)

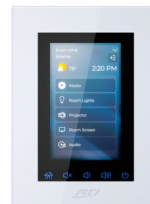

T1-B+

Eight "source" button keycaps located at the top of the T1-B.

Four "general purpose" button keycaps below the power button.



T2i/T2x

Four "general purpose" button keycaps below the touch screen.



# AUDIO DISTRIBUTION



## AD-46-100 4x6 DSP Matrix Amplifier - 100W



Part #: 10-210841-17

Included in the Box:

AD-46-100, AD-46-100 faceplate, power cord, rack ears (2) with screws, 4-pin Phoenix connectors (4), feet with screws (4)

### Specifications

Analog Sources..... 4 RCA (Stereo)  
 Digital Sources..... 2 Coax and 2 Optical (Mirror Analog 1 & 2)  
 Loop Out ..... 4 Analog + 2 Digital  
 Amplified Zones ..... 4 Stereo (8 Channels)  
 Preamp Zones ..... 2 Stereo or 4 Mono (4 Channels)  
 Audio Zone Expansion ..... Up to 48 zones by combining  
 ..... up to 8 AD-46-100 units  
 Input Impedance..... 20kΩ  
 Amplifier..... Class D  
 Power @ 8Ω..... 50W/Ch (all channels driven)  
 Power @ 4Ω..... 100W/Ch (all channels driven)  
 Power @ 8Ω Bridged ..... 200W/Ch bridged (8Ω)  
 ..... (all channels driven)  
 THD-N..... THD+N <0.01%, 1kHz @ 1/8 rated power  
 ..... THD+N <0.05%, 20Hz-20kHz @ 1/8 rated power  
 SNR ..... >95 dB, A-weighted input to output @ rated power @ Amp  
 ..... >100 dB, A-weighted - input to output @ preamp out  
 Frequency Response ..... 20Hz - 20kHz +/- 2 dB @ 4Ω and 8Ω  
 Dynamic Range ..... >95dB A-weighted  
 Sampling Frequency..... 48kHz  
 RTI or 3rd Party Control ..... IP (RJ45), RS-232 (RJ45)  
 ..... and IR (3.5mm mono)  
 AC Input Voltage..... 100-120V/ 220-240V~, 50/60Hz, 800W  
 Power Switch ..... Front Panel On/Off with LED power indicator  
 Mounting..... Rack mount or free-standing  
 Dimensions (W x H x D)..... 17.2" x 16.4" x 3.5"  
 ..... 437 mm x 416.5 mm x 89mm  
 Rack Units ..... 2U  
 Weight ..... 22.88 lb (10.38kg)

The AD-46-100 is a 4x6 DSP Matrix Amplifier for distribution of four audio sources to six zones, with four zones amplified at 100 Watts. Two zones feature preamp outputs to integrate external power amplifiers or subwoofers. The AD-46-100 enables seamless routing of both digital and analog sources to any desired zone and features a comprehensive set of DSP controls. Amplification is with an efficient Class D Cool Power® design that optimizes performance while minimizing heat generation.

### Key Features

- Four analog audio source inputs and two mirrored digital inputs (mirrored analog inputs).
- Six stereo audio output zones with four amplified stereo and two preamp stereo outputs.
- Class D amplifier provides a robust and clear audio experience with 100 Watts @ 4Ω per channel per zone.
- Distribute four audio source inputs to six zones, expandable to 48 zones.
- Fine-tune acoustic characteristics for each zone with the 5-band parametric EQ, mixing and auto-ducking features.
- Configure and optimize DSP and matrix settings.
- Multiple control options with RS-232, IP and IR.
- Configure and optimize DSP and matrix settings directly within Integration Designer or with the intuitive web user interface.
- Rack mount or free-standing installation.

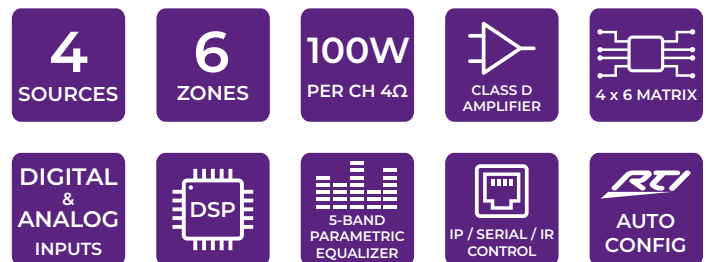

### Analog and Digital Source Inputs

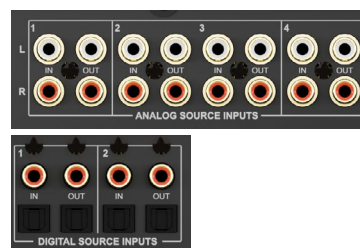

### Preamp and Amplified Outputs

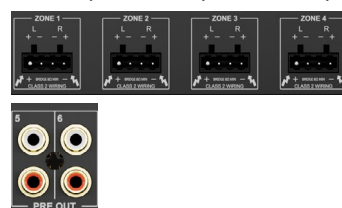

## AD-810-100 8x10 DSP Matrix Amplifier - 100W



Part #: 10-210842-18

**Included in the Box:**

AD-810-100, AD81-100 faceplate, power cord, rack ears (2) with screws, 4-pin Phoenix connectors (8), feet with screws (4)

### Specifications

Analog Sources.....	8 RCA (Stereo)
Digital Sources.....	4 Coax and 4 Optical (Mirror Analog 1 - 4)
Loop Out .....	8 Analog + 2 Digital
Amplified Zones .....	8 Stereo (16 Channels)
Preamp Zones .....	2 Stereo or 4 Mono (4 Channels)
Audio Zone Expansion .....	Up to 80 zones by combining up to 8 AD-810-100 units
Input Impedance.....	20kΩ
Amplifier.....	Class D
Power @ 8Ω.....	50W/Ch (all channels driven)
Power @ 4Ω.....	100W/Ch (2 channels driven)
Power @ 8Ω Bridged.....	200W/Ch bridged (8Ω) (2 channels driven)
Power @ 4Ω Bridged.....	150W/Ch bridged (8Ω) (all channels driven)
THD+N.....	THD+N <0.01%, 1kHz @ 1/8 rated power
THD+N.....	THD+N <0.05%, 20Hz-20kHz @ 1/8 rated power
SNR.....	>95 dB, A-weighted input to output @rated power @Amp
SNR.....	>100 dB, A-weighted - input to output @ preamp out
Frequency Response .....	20Hz – 20kHz +/- 2 dB @ 4Ω and 8Ω
Dynamic Range .....	>95dB A-weighted
Sampling Frequency.....	48kHz
RTI or 3rd Party Control .....	IP (RJ45), RS-232 (RJ45) and IR (3.5mm mono)
AC Input Voltage.....	100-120V/ 220-240V~, 50/60Hz, 1200W
Power Switch .....	Front Panel On/Off with LED power indicator
Mounting.....	Rack mount or free-standing
Dimensions (WxHxD).....	17.2"x16.4"x3.5" / 437 x 416.5 x 89mm
Rack Units .....	2U
Weight .....	23.77 lb (10.78kg)

The AD-810-100 is an 8x10 DSP Matrix Amplifier for distribution of eight stereo audio sources to ten zones, with eight zones amplified at 100 Watts. Two zones feature preamp outputs to integrate external power amplifiers or subwoofers. The AD-810-100 enables seamless routing of both digital and analog sources to any desired zone and features a comprehensive set of DSP controls. Amplification is with an efficient Class D Cool Power® design that optimizes performance while minimizing heat generation.

### Key Features

- Eight analog audio source inputs and four mirrored digital inputs (mirrored analog inputs).
- Ten stereo audio output zones with eight amplified stereo and two preamp stereo outputs.
- Class D amplifier provides a robust and clear audio experience with 100 watts @ 4Ω per channel per zone.
- Distribute eight audio source inputs to ten zones, expandable to 80 zones.
- Fine-tune acoustic characteristics for each zone with the 5-band parametric EQ, mixing and auto-ducking features.
- Configure and optimize DSP and matrix settings.
- Multiple control options with RS-232, IP and IR.
- Configure and optimize DSP and matrix settings directly within Integration Designer or with the intuitive web user interface.
- Rack mount or free-standing installation.

### Analog and Digital Source Inputs

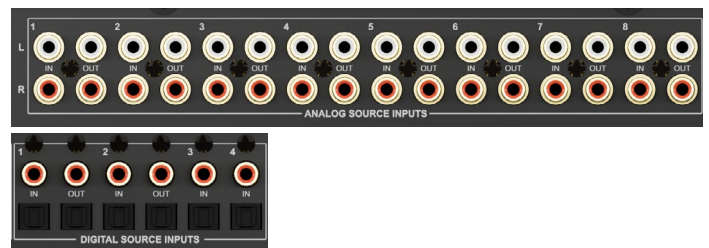

### Preamp and Amplified Outputs





## AD-1616 16x16 Audio Distribution DSP Matrix



Part #: 10-210843-19

Included in the Box:

AD-1616, AD-1616 faceplate, power cord, rack ears (2) with screws, feet with screws (4)

### Specifications

Analog Sources.....	8 RCA (Stereo)
Digital Sources.....	8 Coax and 8 Optical
Loop Out .....	8 Analog + 2 Digital
Amplified Zones .....	Preamp only. Use a CP-16i for amplification
Preamp Zones .....	16 Stereo (32 Channels)
Audio Zone Expansion .....	Up to 64 zones by combining
.....	up to 4 AD-1616 units
Input Impedance.....	20kΩ
Analog Input .....	2 Vrms Maximum
Analog Output.....	2 Vrms Maximum. Volume controlled
Digital Optical Input.....	Up to 192kHz/24Bit sample rate
.....	PCM only
Digital Coaxial Input.....	Up to 192kHz/24Bit sample rate
.....	PCM only
THD-N .....	THD+N <0.01%, 1kHz
.....	THD+N <0.05%, 20Hz-20kHz
SNR .....	>100 dB, A-weighted - input to output @ pre out
Frequency Response .....	20Hz – 20kHz +/- 2 dB
Dynamic Range .....	>95dB A-weighted
Sampling Frequency.....	48kHz
RTI or 3rd Party Control .....	IP (RJ45), RS-232 (RJ45)
.....	and IR (3.5mm mono)
AC Input Voltage.....	100-240V~, 50/60Hz, 20W
Power Switch .....	Front Panel On/Off with LED power indicator
Mounting.....	Rack mount or free-standing
Dimensions (W x H x D).....	17.2" x 16.4" x 3.5"
.....	437 mm x 416.5 mm x 89mm
Rack Units .....	2U
Weight .....	18.12 lb (8.22kg)

The AD-1616 is a DSP Matrix for distribution of sixteen audio sources to sixteen zones. For projects that need more zones, up to four AD-1616 chassis can be combined to deliver 64 audio zones. The AD-1616 enables seamless routing of both digital and analog sources to any desired zone and features a comprehensive set of DSP controls.

For amplification, we recommend pairing the AD-1616 with the RTI CP-16i 16 Channel Cool Power® Amplifier. For projects that need more zones, up to four AD-1616 chassis can be combined to deliver 64 zones.

### Key Features

- Sixteen audio sources inputs with eight analog inputs and eight digital inputs.
- Sixteen preamp stereo audio output zones to integrate external power amplifiers or subwoofers. Preamp outputs require external amplification via RTI CP-16i or third-party audio amplifier.
- Distribute sixteen audio source inputs to sixteen zones, expandable to 64 zones by stacking up to four AD-1616 units.
- Fine-tune acoustic characteristics for each zone with a comprehensive set of DSP controls such as 5-band parametric EQ as well as mixing and auto-ducking features.
- Configure and optimize DSP and matrix settings directly within Integration Designer or with the intuitive web user interface.
- Controlled via IR, and two-way control with feedback via RS-232 and IP when installed with RTI or 3rd party control systems.
- Rack mount or free-standing installation with included rack ears and removable feet.

16  
SOURCES

16  
ZONES

PRE  
AMP

16 x 16 MATRIX

DIGITAL &  
ANALOG  
INPUTS

DSP

5-BAND  
PARAMETRIC  
EQUALIZER

IP / SERIAL / IR  
CONTROL

RTI  
AUTO  
CONFIG

2U  
RACK  
MOUNT

### Analog and Digital Source Inputs

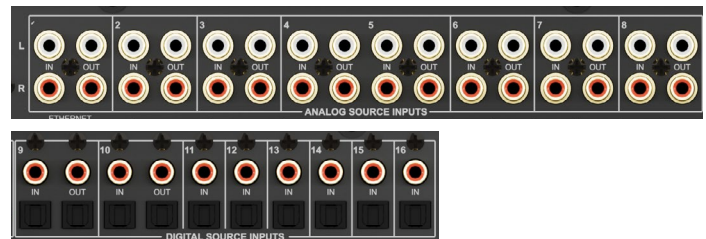

### Preamp and Amplified Outputs

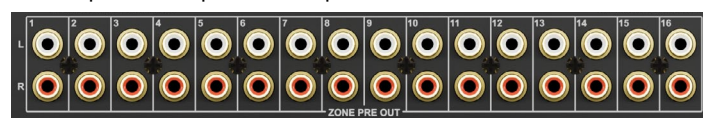

# CP-16i 16 Channel ICEPower® Amplifier



The CP-16i Audio Amplifier is ideal for discerning listeners who demand the highest quality audio in every room. Capable of delivering 100W of true audiophile-grade sound to 16 channels, the ICEpower® amplifier easily expands the reach of any audio distribution system. Engineered for performance, the CP-16i features highly efficient, Class-D amplification, overload detection and a compact chassis that fits nicely into one rack space.

## Key Features

- Sixteen channel amplifier utilizes ICEpower® audio technology.
- Audio output is 100 watts per channel at 4 ohms.
- Bridging audio outputs increases power to 200 watts per channel.
- Easily expands the RTI AD-46-100/AD-810-100 DSP Matrix Amplifiers and the AD-1616 Audio Distribution DSP Matrix.
- Compatible with virtually any audio distribution system.
- Power control via voltage triggers or audio signal sense.
- Signal Sense feature automatically powers the CP-16i on when an audio signal is detected or puts the unit in standby mode when no signal is present.
- Voltage trigger pass-through for powering on/off additional amplifiers.
- Thermal overload and OC (Overcurrent) monitor indicators protect the amplifier.
- Rackmounting requires just 1RU or use included feet for free standing installations.
- Class-D amplifier technology ensures efficient heat dissipation and low power consumption.

Part #: 10-210798-28

### Included in the Box:

CP-16i, power cord, rack ears (2) with screws, feet with screws (4), speaker terminal blocks (8), IO port terminal block (1)

## Specifications

Number of Channels .....	16 channels in 8 stereo zones: ..... each zone can be bridged
Output Power .....	100W per ch. in SE, .....4Ω (1.0%THD+N, 20 Hz - 20kHz) .....200W per ch. in BTL, .....8Ω (1.0%THD+N, 20Hz - 20kHz)
Amplifier .....	Gain: (20Hz - 20kHz) 25.8dB ±0.5dB .....Amplifier Input: Single Ended input - .....1 Vrms max Input Voltage without clipping .....Amplifier Output: Single Ended stage - GND referenced .....Max Output Voltage without clipping is 28Vp
THD + N .....	1.0%, 4Ω, SE, f=100Hz, Po=1W
Dynamic Range .....	110dBA SE, 115dBA BTL
Idle Noise .....	50uV, A-weighted, 20Hz-20kHz
Upper Bandwidth, -3dB.....	100 kHz, 4Ω, SE .....120 kHz, 8Ω, SE
Frequency Response .....	±0.4dB, 10Hz - 20kHz, all loads
Input Impedance.....	47K Ω
Output Serial Impedance.....	30m Ω, f≤1kHz
Signal Sense.....	Audio input sense, .....12V trigger and 3-5V trigger
AC Input Voltage.....	115VAC or 240VAC (Switchable), 230W
Main Power Switch .....	Front Panel On/Off LED
Standby Power Consumption.....	Less than 0.25W
Thermal dissipation .....	2 low noise fans mounted in side panels
Thermal dissipation heat loss .....	0.23 W / 0.8 BTU/hr, standby .....40 W / 135.5 BTU/hr, idle, all ch. .....100 W / 341 BTU/hr, max output power, all, ch. driven
Mounting.....	Rack mount (1RU) or free standing
Dimensions (HxWxD).....	1.7" (44 mm) x 17.25" (438 mm) x .....8.98" (228mm) without connectors .....and 9.30 in (236 mm) deep with connectors
Weight .....	9.0 lbs (4.08 kg)

8

SOURCES

8

ZONES

100W

PER CH 4Ω

200W

BRIDGED

CLASS D  
AMPLIFIER

ICE

power

AUDIO  
TECHNOLOGY

VOLTAGE  
TRIGGER

AUDIO  
SIGNAL  
SENSE

1U

RACK  
MOUNT

### Analog Source Inputs



### Speaker Outputs



## MS-1 Music Streamer

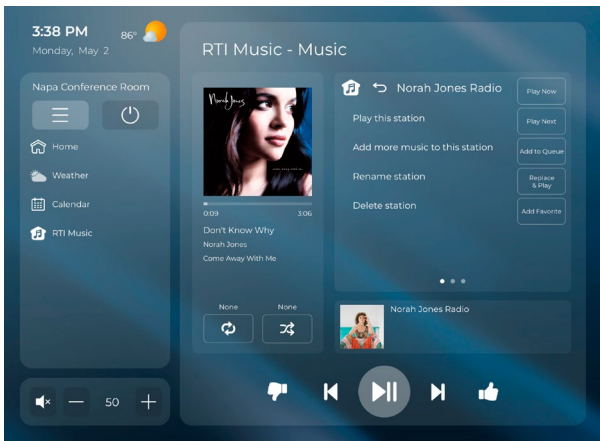

RTI Music's Customizable User Interface

MS-1  
 Part #: 10-210832-17  
 RM-4VIP-2 Rack Mount Kit  
 Part #: 10-210825-19  
 Included in the KX2 Box:  
 MS-1

### Streaming Services

Built-In Residential Streaming Services



Services via Apple AirPlay



Built-In Commercial Streaming Services



More streaming services coming soon ...

### Specifications

Power Supply.....	PoE (802.3af)
Audio Output.....	1 x RCA L/R analog audio
	1 x RCA Digital Coaxial
Digital-to-Analog Conversion.....	Hi-Res 24-bit/192kHz
Sample Rates.....	44.1kHz -192kHz
Ethernet Port.....	1 x LAN RJ45 Connector 10/100Mbps
Control.....	IP
Mounting.....	Free-Standing or Rack Mount
	with optional Rack-Mount Kit RM-4VIP2
Dimensions WxDxH.....	7.5" x 4.75" x 1"
	190.5mm x 120.7mm x 25.4mm
Weight.....	1.47lbs /670g

From the casual listener to the audiophile, streaming music is easier than ever with RTI Music and the MS-1 Music Streamer. Seamlessly deliver Hi-Res Audio (24bit/192kHz) into every room with a tap on a touch panel, remote or the RTI control app on your phone. Whether you are streaming music from your favorite platform or from your local NAS, the MS-1 will outperform your expectations.

RTI Music supports multiple independent sources. Streaming sources include Pandora, Spotify, iHeart Radio, SiriusXM, SiriusXM for Business, SoundMachine, and TuneIn. The AirPlay interface enables streaming from Apple Music and Amazon music. The Music Queue features a play now, play later, and play soon options to build an on-the-fly song queue while the Favorites playlists integrates songs from multiple services and local devices. RTI Music and the MS-1 require an RTI processor for native control within the RTI control system.

### Key Features

- Multiple independent audio sources, one stream.
- Fully integrates with the RTI Integration Designer platform.
- Search through streaming services and local music with an integrated keyboard.
- Search, create, and edit playlist and queues on the fly with "Play Now", "Play Next", and "Play Soon".
- Allows end users the ability to create and add to Pandora stations from any RTI interface.
- One analog output and one digital stereo output (RCA).
- Supports Hi-Res Audio 24bit/192kHz.
- Supported audio formats: FLAC, MP3, AAC, ALAC, OGG Vorbis, WMA, MP4.
- Supports all major streaming services, including Pandora, Spotify, iHeart Radio, SiriusXM, SiriusXM for Business, SoundMachine, and TuneIn.
- Supports Apple AirPlay.
- Supports all RTI remotes, touch panels and keypads as well as iOS and Android smartphones and tablets.
- Easy setup with installation wizard.
- PoE powered
- Remotely manage the clients' RTI Music services.
- RTI Processor required.

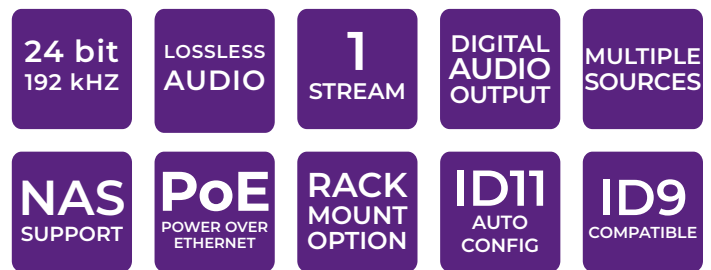

RM-4VIP-2 Rack Mount Kit for up to 4 MS-1 Units (sold separately)  
 Part #: 10-210825-19

## MS-3 Music Streamer

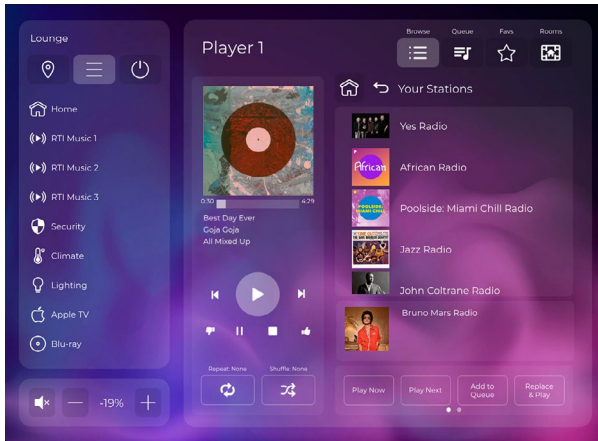

RTI Music's Customizable User Interface

Part #: 10-210829-23

Included in the Box:

MS-3, power supply, rack mount ears (2)

### Streaming Services

Built-In Residential Streaming Services



Services via Apple AirPlay



Built-In Commercial Streaming Services



More streaming services coming soon ...

### Specifications

Power Supply.....	Micro USB 5V 2.5A Power Adapter included
Audio Output.....	3 x RCA L/R analog audio
Digital-to-Analog Conversion.....	Hi-Res 24-bit/192kHz
Sample Rates.....	44.1kHz -192kHz
Ethernet Port.....	1 x LAN RJ45 Connector 10/100Mbps
Control.....	IP
Mounting.....	Rack Mount 1RU
	with included Rack-Mount Kit
Dimensions WxDxH.....	17" x 6" x 1.72"
	431mm x 152mm x 43mm
Weight .....	4.0lbs /1.8kg

From the casual listener to the audiophile, streaming music has never been easier with RTI Music and the MS-3 Music Streamer. Seamlessly deliver Hi-Res Audio (24bit/192kHz) into every room with a tap on a touch panel, remote or the RTI control app on your phone. Whether you are streaming music from your favorite platform or from your local NAS, the MS-3 will outperform your expectations.

RTI Music supports multiple independent sources and allows for three concurrent streams. Streaming sources include Pandora, Spotify, iHeart Radio, SiriusXM, SiriusXM for Business, SoundMachine, and TuneIn. The AirPlay interface enables streaming from Apple Music and Amazon music. The Music Queue features a play now, play later, and play soon options to build an on-the-fly song queue while the Favorites playlists integrates songs from multiple services and local devices. RTI Music and the MS-3 require an RTI processor for native control within the RTI control system.

### Key Features

- Multiple independent audio sources, three concurrent streams.
- Fully integrates with RTI's Integration Designer platform.
- Search through streaming services and local music with an integrated keyboard.
- Search, create, and edit playlist and queues on the fly with "Play Now", "Play Next", and "Play Soon".
- Allows end users the ability to create and add to Pandora stations from any RTI interface.
- Three analog stereo outputs (RCA).
- Supports Hi-Res Audio 24bit/192kHz.
- Supported audio formats: FLAC, MP3, AAC, ALAC, OGG Vorbis, WMA, MP4.
- Supports all major streaming services, including Pandora, Spotify, iHeart Radio, SiriusXM, SiriusXM for Business, SoundMachine, and TuneIn.
- Supports Apple AirPlay.
- Supports all RTI remotes, touch panels and keypads as well as iOS and Android smartphones and tablets.
- Easy setup with installation wizard.
- Remotely manage the clients' RTI Music services.
- Rack-Mount kit included.
- RTI Processor required.

<b>24 bit</b> 192 kHz	<b>LOSSLESS</b> <b>AUDIO</b>	<b>3</b> <b>STREAMS</b>	<b>MULTIPLE</b> <b>SOURCES</b>	<b>NAS</b> <b>SUPPORT</b>
<b>RACK</b> <b>MOUNT</b>	<b>ID11</b> <b>AUTO</b> <b>CONFIG</b>	<b>ID9</b> <b>COMPATIBLE</b>		



## AMR-220 2-Channel Mixer Amplifier – 20W



Part #: 10-210656-21

**Included in the Box:**

AMR-220, power cord, 3-pole pluggable terminal block (1), 4-pole pluggable terminal block (1), RS-232 cable (1), power adapter 24V DC 2.71A (1), plastic cushions (4)

### Specifications

Power Supply .....	+24 VDC
Audio Input.....	Two Line Input Stereo (RCA & 3.5mm jack)
Microphone Input .....	One balanced/unbalanced (3-pin Phoenix Connector),
.....	Switchable Line / 48V Phantom Power
Input Impedance .....	>10KΩ
Audio Output .....	One Stereo Speaker Output (4-pin terminal block)
.....	One Loop Output (3.5 mm jack)
Rated Output Power .....	2 x 20 Watts @ 4Ω / 1 x 40 Watts bridged @ 8Ω
Speaker Impedance .....	4 to 8Ω
Frequency Response.....	20Hz to 20KHz
Signal-to-Noise Ratio.....	80dB at maximum output
Total Harmonic Distortion + Noise @1KHz .....	1% at nominal level
Total Harmonic Distortion + Noise@20KHz .....	0.3% at nominal level
Front Panel Control.....	5 Buttons for Input Select, Volume and EQ
RS232 Control .....	One, Bidirectional control (3-pin Phoenix Connector)
Mounting .....	Surface / wall mount
Dimensions WxHxD .....	4.84" (123mm) x 1.55" (39.5mm) x 3.42" (87mm)

The AMR-220 is a compact-sized Class-D digital mixer/amplifier for classroom or meeting room applications requiring switching of two audio sources (e.g., laptops, video conference systems). Additionally, a microphone can be mixed with the line-level audio sources. The adjustable balanced/unbalanced microphone input supports condenser, dynamic or wireless microphones.

A loop output can be used to share the same audio sources with multiple AMR-220s that power speakers in different audio zones. The AMR-220 offers various control options, including RS-232, as well as a convenient top control panel.

### Key Features

- Two input, one output audio mixer/amplifier.
- Two analog audio inputs (switchable).
- Balanced/unbalanced adjustable microphone input with 48V phantom power for condenser, dynamic or wireless microphones.
- Supports microphone mixing to an audio line source.
- Built-in Class-D amplifier
- Power Output: 2 x 20 Watts (4 Ohms) or 1 x 40 Watts bridged (8 Ohms).
- EQ control (bass / treble).
- RS-232 control.
- Audio loop output to share audio sources with multiple amplifiers.
- Compact form factor with noiseless convection cooler.

# VIDEO DISTRIBUTION



## VIP-UHD-CTRL Video over IP Control Module



Custom User Interfaces VIP-UHD-CTRL

The RTI Video over IP (VIP) distribution platform enables distribution of 4K video over a 1GB network switch to virtually unlimited endpoints. The result is an exceptionally flexible and scalable system that be installed in minutes and controlled natively within the RTI control environment.

The VIP-UHD-CTRL Control Module allows advanced control from any RTI control processor using TCP/IP, RS-232 and IR, and features a web interface module for easy configuration of the system. The Control Module eliminates the need for a deep understanding of complex network infrastructures, yet it is powerful enough to allow independent routing of IR, RS-232, USB / KVM, Audio and Video.

### Key Features

- Simplified Integration Designer® integration with IR, RS-232, or TCP/IP control.
- Wizard-based user interface enables fast and automated configuration of the system. No need to manually assign IP addresses.
- Advanced signal management for independent routing of IR, RS-232, USB / KVM, audio and video.
- Powerful enough to control thousands of end points and multiple videowalls in one system

### Certified Network Switches



- Luxul: AMS Series, XMS Series
- Cisco: SG350 Series, SG550 Series
- Ubiquiti: Edge Series
- Araknis: AN-210, AN-310
- Pakedge: PK-SX
- Netgear: M4250 AV Line Series, M4300 Intelligent Edge Series

Part #: 10-210823-17

Included in the Box:

VIP-UHD-CTRL, IR control cable – 3.5mm o 3.5mm Cable (1), 6-pin Phoenix connector (1), mounting kit (1)

### Specifications

Power Supply.....	PoE or 24-56V 1A DC
Video Input .....	1 x HDMI® Type A, female
Video Output .....	1 x LAN RJ45 Connector
Audio Input .....	1 x 3.5mm L/R analog audio
Audio Output.....	2 x RCA L/R analog audio
Ethernet Ports .....	1 x LAN RJ45 Connector
RS-232 Serial Port .....	1 x 3 Pin Phoenix Connector
USB/KVM Port.....	1 x USB-Type B
IR Input.....	1 x 3.5mm Stereo Jack
IR Output.....	1 x 3.5mm Mono Jack
Firmware Update .....	1 x Micro USB
Mounting.....	Free standing
Dimensions WxDxH.....	7.4" (190mm) x 4.5" (114mm) x 1" (26mm)
Shipping Weight.....	1.8lbs (0.8kg)



### VIP-UHD System Components

- VIP-UHD-CTRL Control Module
- VIP-UHD-TX Transmitter (see next page)
- VIP-UHD-RX Receiver (see next page)



## VIP-UHD-TX 4K Video over IP Transmitter

**VIP-UHD-TX**  
 Part #: 10-210821-15  
**RM-4VIP-2 Rack Mount Kit**  
 Part #: 10-210825-19  
**IRC-SM12V Infrared Adapter Cable**  
 Part #: 40-211168-23



**Included in the KX2 Box:**  
 VIP-UHD-TX, IR receiver (1),  
 IR transmitter (1), serial  
 3-pin Phoenix connector  
 (1), mounting kit (1)

### Specifications

Power Supply.....	PoE or 24-56V 1A DC
Dimensions WxDxH.....	7.4" (190mm) x 4.5" (114mm) x 1" (26mm)
Mounting.....	Rack mount with Rack-Mount Kit (sold separately) or free standing
Shipping Weight.....	1.8lbs (0.8kg)
Video Input.....	1 x HDMI® Type A, female
Video Output.....	1 x LAN RJ45 Connector
Audio Input.....	1 x 3.5mm L/R analog audio
Audio Output.....	2 x RCA L/R analog audio
Ethernet Ports.....	1 x LAN RJ45 Connector
RS-232 Serial Port.....	1 x 3 Pin Phoenix Connector
USB/KVM Port.....	1 x USB-Type B
IR Input.....	1 x 3.5mm Stereo Jack
IR Output.....	1 x 3.5mm Mono Jack
Firmware Update.....	1 x Micro USB

The VIP-UHD-TX is an industry-leading 4K HDCP 2.2 HDMI® transmitter using visually lossless compression technology to deliver HDMI®, Bi-directional IR, RS-232 & USB/KVM up to lengths of 100m over standard network architecture. The VIP-UHD-TX can be powered via PoE from the Network switch or locally should the switch not support PoE. With multiple configuration options available, the VIP solution is ideal for both commercial and residential installations.

### Key Features

- Advanced 4K UHD video over 1Gb Network
- Extends HDMI up to a distance of 100m over a single CAT cable
- Supports up to 4K HDR UHD video sources (3840 x 2160 @30Hz 4:4:4, 4096 x 2160 @24Hz 4:4:4, and 4K @60Hz 4:2:0)
- Supports all known HDMI audio formats including Dolby TrueHD®, Dolby Digital Plus®, and DTS-HD Master Audio® transmission
- PoE powered to keep the rack clean and reduce the need for extra power cords
- HDCP 2.2 compliant with advanced EDID management
- Analog audio embedding and breakout
- Works with top network switches for easy integration

## VIP-UHD-RX 4K Video over IP Receiver

**VIP-UHD-RX**  
 Part #: 10-210822-16  
**RM-4VIP-2 Rack Mount Kit**  
 Part #: 10-210825-19  
**IRC-SM12V Infrared Adapter Cable**  
 Part #: 40-211168-23



**Included in the KX2 Box:**  
 VIP-UHD-RX, IR receiver  
 (1), IR transmitter (1), serial  
 3-pin Phoenix connector  
 (1), mounting kit (1)

### Specifications

Power Supply.....	PoE or 24-56V 1A DC
Dimensions WxDxH.....	7.4" (190mm) x 4.5" (114mm) x 1" (26mm)
Mounting.....	Rack mount with Rack-Mount Kit (sold separately) or free standing
Shipping Weight.....	1.8lbs (0.8kg)
Video Input.....	1 x LAN RJ45 Connector
Video Output.....	1 x HDMI® Type A, female
Audio Output.....	2 x RCA L/R analog audio
Ethernet Ports.....	1 x LAN RJ45 Connector (Video Extension)
RS-232 Serial Port.....	1 x 3 Pin Phoenix Connector
USB/KVM Port.....	2 x USB-Type A
IR Input.....	1 x 3.5mm Stereo Jack
IR Output.....	1 x 3.5mm Mono Jack
Firmware Update.....	1 x Micro USB

The VIP-UHD-RX is an industry-leading 4K HDCP 2.2 HDMI® receiver using visually lossless compression technology to deliver HDMI®, Bi-directional IR, RS-232 & USB/KVM up to lengths of 100m over standard network architecture. The VIP-UHD-RX can be powered via PoE from the Network switch or locally should the switch not support PoE. With multiple configuration options available the VIP solution is ideal for both commercial and residential installations.

### Key Features

- Advanced 4K UHD video over 1Gb Network.
- Extends HDMI up to a distance of 100m over a single CAT cable.
- Supports up to 4K HDR UHD video sources (3840 x 2160 @30Hz 4:4:4, 4096 x 2160 @24Hz 4:4:4, and 4K @60Hz 4:2:0).
- Supports all known HDMI® audio formats including Dolby TrueHD®, Dolby Digital Plus®, and DTS-HD Master Audio® transmission.
- PoE powered to keep the rack clean and reduce the need for extra power cords.
- HDCP 2.2 compliant with advanced EDID management.
- Analog audio breakout.
- LAN loop-out for one-to-many extender mode.
- Works with top network switches for easy integration.



## VEX100-18G-KIT 4K HDBaseT Extender Kit



VEX100-18G-TX



VEX100-18G-RX

VEX100-18G-KIT (1x VEX100-18G-TX + 1x VEX100-18G-RX)

Part #: 10-210824-18

IRC-SM12V Infrared Adapter Cable

Part #: 40-211168-23

Included in the Box:

VEX100-18G-TX (1), VEX100-18G-RX (1), IR receiver (1), IR transmitter (1), 15V/2A DC power supply (1), mounting brackets (2)

### Specifications

#### VEX100-18G-TX Transmitter

Video Input Connectors ..... 1 x HDMI® Type A, female  
 Video Output Connectors ..... 1 x HDBaseT™ RJ45 Connector  
 Audio Output Connectors..... 2 x RCA (L/R), 1 x Optical (SPDIF)  
 Ethernet Port ..... 1 x RJ45 Connector  
 RS-232 Serial Port ..... 1 x DB-9 female  
 IR Input Ports..... 1 x 3.5mm Stereo Jack  
 IR Output Ports..... 1 x 3.5mm Mono Jack  
 Dimensions..... 5.3" x 5.1" x .9" (134mm x 129mm x 22mm)

#### VEX100-18G-RX Receiver

Video Input Connectors ..... 1 x HDBaseT™ RJ45 Connector  
 Video Output Connectors ..... 1 x HDMI® Type A, female  
 Audio Input Connectors ..... 1 x Toslink  
 Ethernet Port ..... 1 x RJ-45 Connector  
 RS-232 Serial Port ..... 1 x DB-9 female  
 IR Input Ports..... 1 x 3.5mm Stereo Jack  
 IR Output Ports..... 1 x 3.5mm Mono Jack  
 Dimensions..... 5.3" x 5.1" x .9" (134mm x 129mm x 22mm)

#### General Specs

Power Supply..... 1 x 15V/2A DC, Screw Connector  
 HDBaseT™ Transmission Distance ..... 1080p@50/60Hz ≤ 328ft (100m)  
 ..... 3840 x 2160 @50/60Hz 4:4:4 ≤ 229ft (70m)  
 Max. Bandwidth ..... 18Gbps  
 Shipping Weight (Kit) ..... 3.5lbs (1.6kg)

Experience exceptional extender performance and flexibility.  
 Extends audio, video, network, and RTI control up to 100m across a single CAT cable.

Supports 4K UHD video from the source to the display.

Sends audio from the display to the audio distribution platform using ARC.

This 4K HDBaseT™ solution delivers ultra-high-resolution HDMI® video with HDCP 2.2 support, bi-directional IR, RS232 and PoH (Power over HDBaseT) up to lengths of 328ft/100m over a single CAT-5e or higher cable. The VEX100-18G-KIT gives integrators the ability to extend the control network without the need for additional cables.

### Key Features

- Advanced HDBaseT™ technology offering uncompressed video and audio with zero latency.
- Supports 4K UHD video up to 70m (Full 3840 x 2160 @50/60Hz 4:4:4 resolution) and 1080P up to a distance of 100m over single CAT cable.
- Supports ARC (Audio Return Channel) from connected display via HDMI® or optical digital inputs.
- Supports Bi-directional IR from all input and output locations and bi-directional RS-232 pass through.
- Supports all known HDMI audio formats including Dolby TrueHD®, Dolby Atmos®, Dolby Digital Plus® and DTS-HD Master Audio® transmission.
- Extend your control network with an integrated Ethernet port (LAN Serving).
- Supports bi-directional PoH (Power over HDBaseT™) to power extender from either the transmitter or receiver end.
- HDCP 2.2 support.

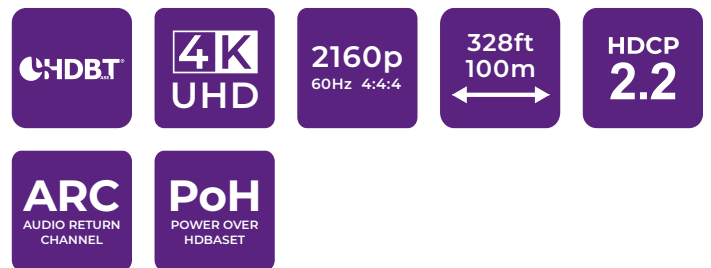

### VEX100-18G-KIT HDBaseT Transmission Distance

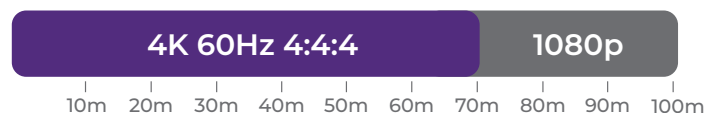

## VX44-18G-Kit 4 x 4 4K HDBaseT™ Matrix Switcher



1x VX44-18G 4x4 HDBaseT Matrix Rear Panel



4x VRX70-18G 4K HDBaseT Receiver Rear Panel

### VX44-18G-Kit (1x VX44-18G + 4x VRX70-18G)

Part #: 10-210818-21

### IRC-SM12V Infrared Adapter Cable

Part #: 40-211168-23

### Included in the Box:

VX44-18G (1), VRX70-18G (4), rack mounting kit (1), remote control (1), IR emitters (4), IR receivers (5), RS-232 control cable (1), IR control cable - 3.5mm-3.5mm cable (1), power cord (1)

## Specifications

### VX44-18G HDBaseT™ Matrix Switcher

Video Input Connectors ..... 4 x HDMI® Type A, 19-pin, female  
 Video Output Connectors ..... 1 x HDMI® Type A, 19-pin, female  
 ..... 4 x HDBaseT™ RJ45 connector  
 HDBaseT™ Transmission Distance ..... 1080p@50/60Hz ≤ 229ft (70m)  
 ..... 3840 x 2160 @50/60Hz 4:4:4 ≤ 131ft (40m)  
 Max. Bandwidth ..... 18Gbps  
 RS-232 serial port..... 1 x 3-Pin Phoenix Connector  
 TCP/IP Control ..... 1 x RJ45, female  
 IR Input ports..... 5 x 3.5mm Stereo Jack  
 IR Output ports..... 4 x 3.5mm Mono Jack  
 Rack-Mountable ..... 1 U rack height, Rack Ears included  
 Dimensions (WxDxH)...17.2" x 15.1" x 2.1" (437mm x 384mm x 53mm)  
 Shipping Weight ..... 11lbs. (5.0kg)  
 Power Supply..... 115VAC or 240VAC

### VRX70-18G HDBaseT™ Receiver

Video Input Connectors ..... 1 x HDBaseT™ RJ45 Connector  
 Video Output Connectors ..... 1 x HDMI® Type A, 19-pin, female  
 Audio Input Connectors ..... 1 x Toslink (S/PDIF)  
 Audio Output Connectors... 1 x Toslink (S/PDIF), 1 x 3.5mm L/R Analog Audio  
 HDBaseT™ Transmission Distance ..... 1080p@50/60Hz ≤ 131ft (70m)  
 ..... 3840 x 2160 @50/60Hz 4:4:4 ≤ 229ft (40m)  
 Max. Bandwidth ..... 18Gbps  
 RS-232 serial port..... 1 x 3-Pin Phoenix Connector  
 IR Input ports..... 1 x 3.5mm Stereo Jack  
 IR Output ports..... 1 x 3.5mm Mono Jack  
 Mounting Kit ..... Included  
 Dimensions (WxDxH)..... 5.5" x 3.3" x .7" (140mm x 84mm x 18mm)  
 Shipping Weight ..... 1.3lbs. (0.6kg)  
 Power Supply..... 1x 12V/1A DC, Screw Connector

The RTI 4x4 HDBaseT™ Matrix combines exceptional performance with outstanding value for custom integrators world-wide. The VX44-18G-KIT is an HDMI 2.0 4K 60Hz 4:4:4 HDCP 2.2 matrix using Color Space Conversion (CSC) technology to deliver HDMI, Bi-directional IR and PoC up to lengths of 70m over a single CAT cable. The Matrix delivers advanced features including simultaneous HDBaseT™/HDMI on output 1, video down-conversion on HDBaseT™ outputs and a web browser interface module for simple configuration of the Matrix. Four (4) receivers are included in this kit.

## Key Features

- Advanced HDBaseT™ technology enables distribution of video and audio over a single CAT cable.
- Advanced Color Space Conversion (CSC) supports
- HDMI® 2.0 18Gbps specification including HDR.
- The four (4) HDMI® inputs can be independently routed to four (4) HDBaseT™ outputs with output 1 featuring simultaneous HDMI® and HDBaseT™ output.
- Video down-conversion on HDBaseT™ outputs allows a display only capable of supporting lower video resolutions (4K 60Hz 4:2:0 or 1080p) to receive 4K.
- 60Hz 4:4:4 video content while still showing maximum original 4K UHD resolution on remaining video outputs.
- Supports 4K 60Hz 4:4:4 UHD video up to 131ft (40m) and 1080p video up to 229ft (70m).
- Supports all industry standard video resolutions including VGA-WUXGA and 480i-4K and all known HDMI® audio formats including Dolby TrueHD®, Dolby Atmos®, Dolby Digital Plus® and DTS-HD Master Audio® transmission.
- Control via front panel , IR, RS-232 and TCP/IP.
- Supports PoC (Power over Cable) to power compatible HDBaseT™ receivers.
- Advanced EDID management and HDCP 2.2 compliant.

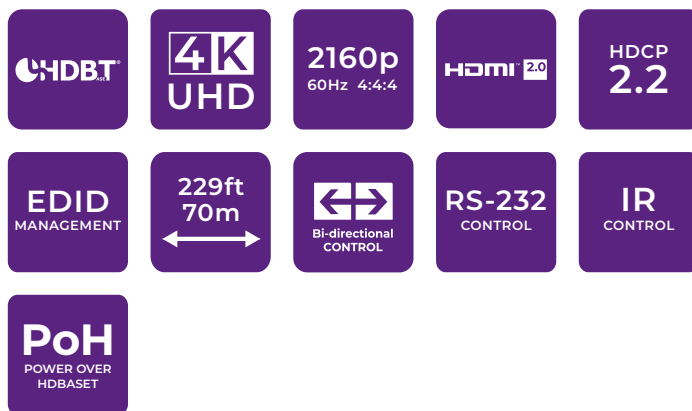

### VX44-18G-KIT HDBaseT Transmission Distance

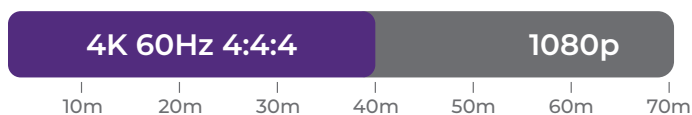

## VX88-18G 8 x 8 4K HDBaseT™ Matrix Switcher



**VX88-18G**

Part #: 10-210819-22

IRC-SM12V Infrared Adapter Cable

Part #: 40-211168-23

**Included in the Box:**

VX88-18G (1), rack mounting kit (1), remote control (1), IR emitters (8), IR receivers (9), RS-232 control cable (1), IR control cable - 3.5mm-3.5mm cable (1), power cord (1)

### Specifications

Video Input Connectors .....	8 x HDMI Type A, 19-pin, female
Video Output Connectors .....	1 x HDMI Type A, 19-pin, female
.....	8 x HDBaseT RJ45 connector
HDBaseT™ Transmission .....	1080p@50/60Hz ≤ 229ft (70m)
Distance .....	3840 x 2160 @50/60Hz 4:4:4 ≤ 131ft (40m)
Max. Bandwidth .....	18Gbps
RS-232 serial port.....	1 x 3-Pin Phoenix Connector
TCP/IP Control .....	1 x RJ45, female
IR Input ports.....	9 x 3.5mm Stereo Jack
IR Output ports.....	8 x 3.5mm Mono Jack
Rack-Mountable.....	1 U rack height, Rack Ears included
Dimensions (WxDxH).....	17.2" x 15.1" x 2.1" (437mm x 384mm x 53mm)
Dimensions w/o feet (WxDxH) .....	17.2" x 14.8" x 1.7" (437 x 377 x 44mm)
Shipping Weight.....	11lbs. (5.0kg)
Power Supply.....	115VAC or 240VAC

The 8x8 HDBaseT™ Matrix combines exceptional performance with outstanding value for custom integrators world-wide. The VX88-18G is a HDMI® 2.0 4K 60Hz 4:4:4 HDCP 2.2 matrix using Color Space Conversion (CSC) technology to deliver HDMI®, Bi-directional IR and PoC up to lengths of 70m over a single CAT-5e or higher cable. The Matrix delivers advanced features including simultaneous HDBaseT™/HDMI® on output 1, video down-conversion on HDBaseT™ outputs and a web browser interface module for simple configuration of the Matrix.

### Key Features

- Advanced HDBaseT™ technology enables distribution of video and audio over a single CAT cable.
- Advanced color Space Conversion (CSC) supports HDMI® 2.0 18Gbps specification including HDR.
- The 8 HDMI inputs can be independantly routed to 8 HDBaseT outputs with output 1 featuring simultaneous HDMI and HDBaseT output.
- Video down-conversion on HDBaseT™ outputs allows a display only capable of supporting lower video resolutions (4K 60Hz 4:2:0 or 1080p) to receive 4K 60Hz 4:4:4 video content while still showing maximum original 4K UHD resolution on remaining video outputs.
- Supports 4K 60Hz 4:4:4 UHD video up to 131ft (40m) and 1080p video up to 131ft (70m).
- Supports all industry standard video resolutions iand all known HDMI® audio formats including Dolby TrueHD®, Dolby Atmos®, Dolby Digital Plus® and DTS-HD Master Audio® transmission.
- Control via front panel , IR, RS-232 and TCP/IP.
- Supports Power over Cable to power compatible HDBaseT receivers.
- Advanced EDID management and HDCP 2.2 compliant.

## VRX70-18G 4K HDBaseT™ Receiver



Part #: 10-210820-14

**Included in the Box:**

VRX70-18G (1), mounting kit (1)

### Specifications

Video Input Connectors .....	1 x HDBaseT™ RJ45 Connector
Video Output Connectors .....	1 x HDMI® Type A, 19-pin, female
Audio Input Connectors .....	1 x Toslink (S/PDIF)
Audio Output Connectors.....	1 x Toslink (S/PDIF)
.....	1 x 3.5mm L/R Analog Audio
HDBaseT™ Transmission .....	1080p@50/60Hz ≤ 131ft (70m)
Distance .....	3840 x 2160 @50/60Hz 4:4:4 ≤ 229ft (40m)
Max. Bandwidth .....	18Gbps
RS-232 serial port.....	1 x 3-Pin Phoenix Connector
IR Input ports.....	1 x 3.5mm Stereo Jack
IR Output ports.....	1 x 3.5mm Mono Jack
Mounting Kit.....	Included
Dimensions (WxDxH).....	5.5" x 3.3" x .7"
.....	140mm x 84mm x 18mm
Dimensions (WxDxH).....	5.5" x 3.5" x .7"
(including connectors).....	140mm x 88mm x 18mm
Shipping Weight.....	1.3lbs. (0.6kg)
Power Supply.....	1x 12V/1A DC, Screw Connector

The VRX70-18G HDMI 2.0 4K 60Hz 4:4:4 (18Gbps) HDCP 2.2 HDBaseT™ Receiver pairs perfectly with the VX44-18G-Kit\* and the VX88-18G and offers market-leading features and outstanding value, including Color Space Conversion (CSC) technology. The product extends HDMI, Bi-directional IR, and is powered by the matrix up to lengths of 70m (4K 40m). The VRX70-18G HDMI 2.0 4K 60Hz 4:4:4 (18Gbps) HDCP 2.2 HDBaseT™ Receiver pairs perfectly with the VX44-18G-Kit\* and the VX88-18G and offers market-leading features and outstanding value, including Color Space Conversion (CSC) technology. The product extends HDMI, Bi-directional IR, and is powered by the matrix up to lengths of 70m (4K 40m).

\* The VX44-18G-Kit comes with 4 x VXR70-18G

### Key Features

- Advanced HDBaseT™ technology enables distribution of video and audio over a single CAT cable.
- Advanced color Space Conversion (CSC) supports HDMI® 2.0 18Gbps specification including HDR.
- Supports all industry standard video resolutions including VGA-WUXGA and 480i-4K and all known HDMI® audio formats including Dolby TrueHD®, Dolby Atmos®, Dolby Digital Plus® and DTS-HD Master Audio® transmission.
- HDMI® re-clocking to help solve HDMI® HDCP, compatibility and handshaking issues.
- IR pass-through to compatible HDBaseT™ devices.
- Supports bi-directional PoC (Power over Cable) from VX88-18G.
- HDCP 2.2 support.



# VXT-Ux X-Series HDBaseT™ Class-C Video Extender Set



VXT-URx HDBaseT receiver & VXT-UTx HDBaseT transmitter

Part #: 10-210781-20

**Included in the Box:**

VXT-URx HDBaseT receiver, VXT-UTx HDBaseT transmitter, Infrared blaster cable pack (TX/RX pack), power supply 48V/0.5A

## Specifications

Power Supply .....	1 x 48V @ 0.5A (Transmitter only)
..... Receiver is powered via Power .....	over HDBaseT (PoH) from Transmitter
Power Consumption .....	Transmitter: 7.3W / Receiver: 8W
Wall Mountable .....	Yes - brackets sold separately
Dimensions (HxWxD).....	0.51" x 5.82" x 4.13"
.....	(13mm x 148mm x 105mm) each
Weight .....	0.35 lbs (160g) each
Operating Temperature .....	0 to +35°C (+32 to +95°F)
Operating Humidity .....	20 to 90% RH Non-condensing
Transmitter Video Input .....	One HDMI
Transmitter Video Output ....	One HDBaseT Class C + DSC (PoH) (RJ45)
Receiver Video Input .....	One HDBaseT Class C + DSC (PoH) (RJ45)
Receiver Video Output .....	One HDMI
HDBaseT Transmission Distance .....	1080P@60Hz ≤492ft (150m)
.....	4K@60Hz ≤328ft (100m)
ARC (Audio Return Channel) .....	Yes
DSC (Display Stream Compression) .....	Yes
Ethernet Pass-through .....	Yes
HDBaseT Recommended Cable .....	Cat5e or greater
Color Supported .....	4K: 12bit, 1080p: 12bit
Color Depth .....	Up to 36bit (3x 12bit)
TMDS Clock Speed .....	600Mhz
Max Bandwidth .....	18Gbps
Compliance .....	HDCP 1.4 and HDCP 2.2
PoH .....	PoH (Power over HDBaseT) Transmitter to Receiver
RS-232 Control.....	One Bi-Directional , 3.5mm jack
Infrared Control .....	One IR In, One IR Out, 3.5mm jacks
CEC Control .....	Full

### VXT-UTx Transmitter

The VXT-UTx HDBaseT Transmitter delivers visually lossless HDMI 1080p video signal over a single Cat5e/6/7 cable up to 492ft (150m) and a 4K signal up to 328ft (100m) to the VXT-URx HDBaseT Receiver using Display Stream Compression. The VXT-UTx powers the VXT-URx through the Category cable using PoH (Power over HDBaseT). It also transmits an IR or RS232 signal through the same cable to control the remote display or projector.

### VXR-UTx Receiver

The VXT-URx HDBaseT Receiver receives visually lossless HDMI video signal over a single Cat5e/6/7 cable from a VXT-UTx HDBaseT Transmitter or from a VHU-8x HDBaseT Matrix Switcher using Display Stream Compression. The VXT-URx is powered through the connected Category cable using PoH (Power over HDBaseT). It also receives an IR or RS232 control signal through the same cable and delivers it to the connected display or projector.

## Key Features

- Extends HDMI video 1080p up to 492ft (150m) and 4K up to 328ft (100m) over a single Cat5e cable or greater.
- Supports HDR and 4K@60Hz 4:4:4 and 1080p@60Hz, 3D.
- HDMI-CEC Bi-Directional Control.
- Bi-Directional IR Control.
- Serial RS232 via 3.5mm.
- PoH Power over HDBaseT (receiver).
- Wall mountable (brackets sold separately).
- HDCP 2.2 compliant.
- Automatic EDID support.
- Low Profile.
- Full HDMI Audio support.
- ARC (Audio Return Channel), enabling audio from the TV to be returned to the remote location with just the HDMI cable.
- Ethernet 10/100 Connection.
- Audio return via Analogue or Toslink (Mini-toslink adapter not included).
- DSC support - for HDR and 4K/60 4:4:4 over HDBaseT link.

### VXT-Ux HDBaseT Transmission Distance

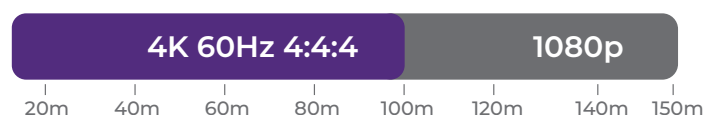



## VDA-14 HDMI® 2.0 Splitter



The VDA-14 is an HDMI® splitter that delivers 4K video signal from one source to up to four displays simultaneously. Compliant with HDMI2.0 and HDCP2.2, VDA-14 supports resolutions up to 4K and supports 3D at 1080.

By auto-detecting the input resolution and with the built-in EDID management, the VDA-14 automatically adjusts the output resolution to fit the connected displays.

### Key Features

- Provides distribution of one video source to up to four displays/projectors simultaneously.
- HDCP 2.2 compliant, supporting HDMI® 2.0, backwards compatible with all previous HDMI® standards.
- Supports HDMI® / DVI resolutions up to 4K@60Hz 4:4:4.
- Up to 10m cable length for 4K resolution when using 24 AWG HDMI® cables.
- Auto-detect of input resolution.
- Built-in EDID management adjusts output resolution to fit all connected displays.
- LEDs indicate connection and HDCP compliance status.

Part #: 10-210653-18

**Included in the Box:**

VDA-14, mounting ears (2) with screws, plastic cushions (4), power adapter 5 VDC (1)

### Specifications

Power Supply.....	+5 VDC, 2A
Mounting.....	Wall / Surface mount or Free standing
Digital Video Input .....	One HDMI®
Digital Video Output .....	Four HDMI®
Compliance .....	HDMI® 2.0, HDCP 2.2
Resolution Range .....	720x480@60Hz to 4K@60Hz 4:4:4, 1080p 3D
Supported Audio Formats .....	Dolby Digital, DTS, DTS-HD, PCM
EDID Management.....	Built-in EDID management
Front Panel LEDs.....	Connection Status, HDCP Compliance Status
USB .....	Micro USB for Firmware Update
Dimensions WxHxD.....	5.98" x 0.43" x 2.75" (152 x 11 x 70mm)
Weight .....	0.3 lbs (140g)

# WORKSPACE SOLUTIONS



**RTI**

**MEDIA XCHANGE**  
X

**Media Xchange**  
1. Plug Transmitter into your computer  
2. Device paired when LED stops flashing  
3. Press the button to start sharing your screen

**Miracast**  
1. Connect to the Wi-Fi network  
2. Go to the Dashboard  
3. Select Smart View® or Screen Cast and choose device

**AirPlay**  
1. Connect to the Wi-Fi network  
2. Go to the Control Center  
3. Select Screen Mirroring and choose device

**PC**  
1. Connect to Wi-Fi network  
2. Press **Windows** + K to show the cast menu  
3. Select the appropriate device

# UC-IVB-50 Intelligent Video Bar

## Make Every Meeting an In-Person Meeting



UC-IVB-50 Intelligent Video Bar Rear View

Part #: 10-210845-21

**Included in the Box:**

UC-IVB-50 4K Intelligent Video Bar (1), Bluetooth remote controller (1), 16.4ft/5m 4K HDMI 2.0 cable (1), 16.4ft/5m USB 3.0 USB-A to USB-B cable (1), magnetic lens cap (1), wall mounting kit (1), DC 24V power adapter with US IEC cable (1), drywall anchors (4), mounting screws (4)

### Specifications

Video Interface	1 x HDMI in, 1 x HDMI out, 1 x USB-C, 1 x USB-B, 1 x USB-A, 1 x Mic, 1 x GbE, 1 x DC
Video Resolutions	4K@30Hz (Max)
Output Video Encoding	MJPEG/YUY2/NV12/H.264/H.265   UVC 1.1
Camera Sensor	8.0 MP CMOS
Viewing Angle	120° FOV (Field of View)
ePTZ	Supported   5 x Digital Zoom
HDR	Supported
Tracking Mode	Auto Framing / Speaker Tracking / Presenter Tracking
Microphone	4 x MEMs Linear (180°) Microphone Arrays
	Pick-up Range: 16.4ft/5m~26.2ft/8m
DSP	ANS, AEC, AGC
Speaker	2 x 8W with Bass Radiators
Communication and Control	
HDMI	HDMI 1.4, HDCP 2.2
USB-C	USB 3.0 host with DP In and PD (60W max charging)
USB-A	USB 3.0 Device
USB-B	USB 3.0 Host
Micro USB-B	Custom 10-Pin for UC-IVB-EXM
USB Protocol	UAC, UVC, USB HID
Ethernet	1 x RJ-45: 1000Base-T (1GbE)
WiFi	IEEE 802.11 a/b/g/n/ac
BYOD	Media Xchange™, Airplay®, Miracast®
Compatible OS	Windows 10 or above
	Mac OS 10.15 or above
Control Method	RTI Integration, Web UI, Bluetooth Remote Controller, or TCP/IP API
Mounting	Wall-Mount and Tabletop Mount included
	TV Mount (sold separately)
Power Supply / Consumption	DC 24V 5A, 100W (Max)
Dimensions (WxHxD)	27.44" x 3.06" x 3.13" (697 x 78 x 80mm)
Product Weight	5.324lb (2.42kg)

The Intelligent Video Bar is the centerpiece of the RTI Intelligent Meetings Ecosystem. From huddle spaces to large conference rooms, RTI Intelligent Meetings enables the audio, video, and collaboration needed in today's hybrid work environment.

Host more efficient, engaging, and productive meetings, elevating the quality of interactions and outcomes on your preferred conferencing platform.

#### Intuitive Meeting Room Experience

- Clear instructions for all presenters, with Wi-Fi connectivity information for guests.
- Customizable background.
- Multiple connection types:
  - AirPlay®, Miracast®, PC, and Media Xchange™.

### Key Features

#### Advanced Hardware

- Collaborate clearly in 4K UHD.
- Capture every voice with linear beam-forming microphone array.
- Hear everything through two full-range 8-Watt speakers with bass radiators.
- Focus on what is important with the Intelligent 4K Camera, featuring 120° Field-of-View and AI tracking.

#### Seamless Collaboration

- Connectivity App Ready: Works with Zoom, Microsoft Teams, WebEx, and more.
- Wired BYOM Connectivity: 4K UHD HDMI™ input and USB 3.0 or USB-C
- Wireless BYOD Connectivity: Media Xchange™, AirPlay®, and Miracast®.
- Media Xchange™: Wireless transmitter for click-and-go sharing.

#### Control

- Native RTI integration enables full room control.
- Standalone with integrated web interface and remote control.
- Full-featured API for infinite integration options.

#### Mounting Options

- Wall & tabletop mount included; TV mount sold separately.





## UC-MXT Media Xchange™ Transmitter for UC-IVB-50



Part#: 10-210846-22

The Media Xchange™ Transmitter enables wireless connectivity to the Intelligent Video Bar. The result is a seamless bring-your-own-device (BYOD) experience for meetings of all sizes.

The Media Xchange Transmitter conveniently plugs into the USB-C port on laptops and mobile devices and shares the signal to the video screen with an ultra-low latency 1080p 30Hz video transmission. Sharing is as simple as tapping the Media Xchange button. The Privacy button enables screen pausing or blocking.

### Key Features

- Up to 2 Media Xchange wireless transmitters with each UC-IVB-50.
- USB-C connectivity for mobile devices and laptops.
- Privacy button for quick access to screen pausing or blocking.
- Ultra-low latency 1080p 30Hz video transmission.
- HID USB routing from HID touch-capable display back to source.
- 2.4 and 5GHz wireless bands support.
- Operates by using USB-C DisplayPort Alt mode.
- MAC OS, Windows 7/10/11, and Android supported.

### Specifications

Max Resolution.....	1080P@30Hz
Terminal Type.....	1 x Type-C
Frequency.....	5GHz (default) and 2.4GHz
Input Voltage.....	5V (Power over USB)
Power Consumption (Max).....	2.14W
Dimensions (ØxHxL).....	2.72" x 0.65" x 6.50"
.....	68.98mm x 16.4mm x 165.19mm
Product Weight.....	0.13lb/60g

## UC-IVB-EXM Expansion Microphone for UC-IVB-50



Part #: 10-210847-23

In spaces where users are situated beyond the recommended range of the built-in MEMs array microphones in the UC-IVB-50, one or more UC-IVB-EXM Expansion Microphones elevate the audio pickup in the room to make sure all participants are heard.

Sound quality is enhanced with an integrated DSP featuring Acoustic Echo Cancellation (AEC), Automatic Noise Suppression (ANS), and Automatic Gain Control (AGC).

### Key Features

- Connect up to 5 UC-IVB-EXM expansion microphones to an RTI UC-IVB-50
- An integrated DSP features Acoustic Echo Cancellation, Automatic Noise Suppression, and Automatic Gain Control.
- An LED-lit capacitive-touch microphone mute button is available with synchronization across all devices.
- Omnidirectional (360°) Microphone Array with a ~3m pickup range.
- Connect 3 UC-IVB-EXM with a total cable length of 50m of CAT-6 (maximum of 25m CAT-6 with 5 UC-IVB-EXMs).

### Specifications

Microphone.....	Omnidirectional (360°) Microphone Array
.....	Pick-up Range: 9.8ft/3m
Frequency Response.....	100Hz - 10kHz
Sensitivity.....	-26dBFS
Signal-to-Noise Ratio.....	62dB
DSP.....	Full Duplex, AEC (Automatic Echo Cancellation), AGC
.....	(Automatic Gain Control), ANS (Automatic Noise Suppression)
Input / Output.....	RJ-45
Power Supply / Consumption.....	Powered by UC-IVB-50, 1.5W (Max)
Dimensions (ØxH).....	4.25" x 1.04"/108mm x 26.5mm
Product Weight.....	0.31lb/140g

## UC-IVB-TM TV Mount for UC-IVB-50



Part #: 10-210848-24

The UC-IVB-TM optional TV Mount enables the Intelligent Video Bar to be mounted directly to the back of the room's TV monitor. This is especially useful when the TV is mounted on a stand, rather than to the wall.

### Specifications

Mount Compatibility .	VESA Mount Compatible; TV Mount with vertical VESA brackets required
TV Mount Compatibility.....	VESA compatible; 200mm - 600mm patterns
Tilt Adjustable.....	30° up tilt range
Assembly Required.....	Yes
Mount Location.....	Below TV
Material / Color.....	Steel, black
Indoor / Outdoor.....	Indoor only
Dimensions (WxHxD).....	26.4" x 19.41" x 2.09" / 670mm x 493mm x 53mm
Product Weight.....	4.69lb/2.13kg



# VXP-82 8x2 All-in-One Control Processor & AV Presentation Switcher

## Single box solution - reduces cabling and installation time

Time-saving  
ID File  
included



Front View



Rear View

Part #: 10-210638-21

**Included in the Box:**

VXP-82, rack ears (2) with screws (6), power cord, Phoenix connectors (3.5mm, 3 Pins) (2), Phoenix connectors (3.5mm, 5 Pins) (2), terminal blocks (3 x 4 position, 3x 2 position), RS-232 adapters (2)

### Specifications

AC Input Voltage .....	110VAC ~ 240VAC, 50-60Hz
Mounting.....	Rack mount, 2 RU or free standing
Video Input .....	3 x HDMI®, 1 x Display Port, 2 x VGA (female 15-pin)
.....	2 x HDBaseT™ (PoH) (RJ45)
Video Output .....	1 x HDMI®, 1 x HDBaseT™ (RJ45)
Resolution Range.....	800x600@60Hz to 4Kx2K@60Hz
HDBaseT™ Transmission Distance .....	1080p@60Hz ≤ 100m
.....	4Kx2K@60Hz ≤ 90m
EDID.....	Built in EDID data and manual EDID management
HDCP .....	Supports up to HDCP 2.2
Audio Input.....	1 x Mono analog, 2 x 3-pole 3.5mm, Mic/line level
Audio Output.....	2 x Stereo de-embedded
Phantom Power .....	Enable/Disable per channel
Analog Line Output with DSP .....	2-Channel stereo
Frequency Response .....	20Hz to 20kHz ≤ 3 db
Infrared Output.....	6 x 3.5mm, 1 x High output
Infrared Frequency Transmission Range.....	15kHz - 460kHz
Trigger Outputs.....	3 x 12 VDC, 100mA max each
Relays .....	3 x 5 Amps @ 30 VDC
Sense Inputs .....	3 x 3-24 VDC
RS232 Ports.....	2 x Bidirectional control (RJ45)
Expansion Port .....	1 x RJ45 Connection
RTICOM Port.....	1 x Zigbee®, RJ45 Connection
Ethernet Port .....	1 x 10/100BaseT, RJ45 - Ethernet Pass-through
LAN Port .....	1 x 10/100BaseT, RJ45 - WebGui access
USB Ports .....	USB-A: 1 x scaler upgrade, 2 x USB devices (KVM)
.....	Micro-USB: 1 x Firmware update
.....	USB-B: 2 x Host inputs
Dimensions WxHxD .....	17.32" x 3.5" x 13" (440 x 89 x 330mm)
Weight .....	14 lbs (6.35kg)

The VXP-82 combines a robust control processor with a built-in Audio/Video presentation switcher to deliver a single-box solution for conference rooms, classrooms, and lecture halls. The VXP-82 enables control from RTI touch panels, keypads, remote controls, or mobile apps, while its 8x2 switcher distributes Audio/Video signals over HDMI® and HDBaseT™ simultaneously to one or two rooms. Existing in-room USB web conferencing cameras, microphones and speakers can be connected and switched as well as traditional analog or digital audio and video sources such as computers / laptops, document cameras, media servers and streamers, DVD players, and microphones.

Thus, the VXP-82 is ideal for BYOD settings and social distancing office configurations. KVM control over USB allows for multiple presentation control options using USB keyboard and mouse from different spots in the same or secondary room. Additional features include a 4K video scaler and an audio mixer.

### Key Features

- 8x2 4K All-in-One Scaling Presentation Matrix Switcher.
- Support for HDCP 2.2 and HDMI 2.0.
- Built-in scaler supports up to 4K@60Hz 4:4:4 8bit video output.
- HDBaseT inputs/output using VXP-R/VXP-T Extenders:
- Cat-5 cable: 4K@60Hz 4:2:0 8bit signal up to 90m/300ft, 1080p@60Hz 4:4:4 8bit signal up to 100m/330ft
- Cat-6/6a/7 cable: 4K@60Hz 4:2:0 8bit signal up to 100m/330ft, 1080p@60Hz 4:4:4 8bit signal up to 100m/330ft.
- VXP-R/VXP-T HDBaseT Extenders support PoH (Power over HDBaseT) in addition to Ethernet, IR and RS-232 pass-through.\*
- Bi-directional KVM functionality for HDMI or HDBaseT outputs - Ideal for presentation settings.\*
- Supports de-embedded audio of HDMI and HDBaseT outputs, set independently to output any mixed result.
- Control via front panel, built-in processor, and Web UI.
- Built-in control processor with 128Mb of non-volatile flash memory.
- Control of external devices via six routable IR ports, two RS-232 ports, three relays, three voltage triggers, and three voltage sense inputs.
- Support for RTI wired and wireless controllers (remote controls require RTI RM-433 433MHz or ZM-24 2.4GHz Zigbee antennas).
- Support for RTIPanel App control.
- Flexible installation options with tabletop or rack-mount design.

\* NOTE: Support for PoH, IR/RS-232/Ethernet pass-through and KVM functionality over HDBaseT require VXP-R and VXP-T Extenders.

# VXP-T HDBaseT Long Range Transmitter

# VXP-R HDBaseT Long Range Receiver



VXP-T HDBaseT™ Transmitter



VXP-R HDBaseT™ Receiver

VXP-T and VXP-R are sold separately

**VXP-T Transmitter**  
Part #: 10-210769-26

**VXP-R Receiver**  
Part #: 10-210770-18

**Included in the Box:**  
VXP-T or VXP-R, mounting brackets (2) with screws, 12VDC/2A power supply (1) with US, EU, UK, AU plugs, Phoenix connector 3.5mm, 3 Pin (1), Phoenix connector 3.5mm, 2 Pin (1)

The VXP-T (transmitter) and VXP-R (receiver) are designed for use with the VXP-82 Presentation Switcher & Control Processor to extend high-resolution video, audio, Ethernet, control and KVM signals over long distances up to 492ft (150m) via a single Cat5e/Cat6 cable. In combination with the VXP-82 multiple video sources can be distributed to up to up to two displays.

Easy wiring and the high bandwidth capability of these Class B HDBaseT™ extenders make them ideal for any commercial or residential setting where video sources are installed in a central AV rack and TVs or presentation displays are distributed throughout multiple areas such as conference rooms, huddle spaces, restaurant dining rooms, or home media rooms.

Both the transmitter and the receiver can also be used as stand-alone signal extension for point-to-point transmission.

## Specifications

### VXP-T Transmitter

Video Input ..... One HDMI®  
HDBaseT Output ..... One, HDBaseT (PoH) (RJ45)  
Audio ..... One, Stereo Audio (1 x 3.5mm jack)  
..... One in, One Out, Digital Audio (S/PDIF)  
Control Signal Ports ..... One, IR in, 3.5mm jack, One, IR out, 3.5mm jack  
..... One, RS-232 bidirectional, 3-pin Phoenix Connector  
Ethernet ..... Two, RJ45  
USB Host ..... One, USB B-Type  
USB Device ..... Two, USB A-Type  
Power Supply ..... 12VDC 2A (transmitter powers receiver  
..... via Power over HDBaseT)

### VXP-R Receiver

HDBaseT Input ..... One, HDBaseT (PoH) (RJ45)  
Video Output ..... One HDMI®  
Audio ..... One, Stereo Audio (1 x 3.5mm jack)  
..... One In, One Out, Digital Audio (S/PDIF)  
Control Signal Ports ..... One, IR in, 3.5mm jack, One, IR out, 3.5mm jack  
..... One, RS-232 bidirectional, 3-pin Phoenix Connector  
Ethernet ..... Two, RJ45  
USB Host ..... One, USB B-Type  
USB Device ..... Two, USB A-Type

### General

Input/Output Signal Type ..... HDMI® with 4K@60Hz 4:2:0 (or 4K@30Hz  
..... when connected with VXP-82), HDCP 2.2, HDBT  
Compliance ..... HDMI® 2.0, HDCP 2.2  
Input / Output Resolutions ..... 800 x 600@60Hz, 1024 x 768@60Hz,  
..... 1280 x 768@60Hz, 1280 x 800@60Hz, 1280 x 960@60Hz,  
..... 1280 x 1024@60Hz, 1360 x 768@60Hz, 1366 x 768@60Hz,  
..... 1440 x 900@60Hz, 1600 x 900@60Hz, 1600 x 1200@60Hz,  
..... 1680 x 1050@60Hz, 1920 x 1200@60Hz, 2048 x 1152@60Hz,  
..... 3840 x 2160@24Hz/25Hz/30Hz/50Hz\*/60Hz\*,  
..... 4096 x 2160 @24Hz/25Hz/30Hz/50Hz\*/60Hz\*,  
..... 1280 x 720P@50Hz/59.94Hz/60Hz, 1920 x 1080P@50Hz/59.94Hz/60Hz  
Color Sampling ..... 4:4:4, 4:2:2, :2:0, Resolutions with an asterisk \*: 4:2:0  
Audio Formats ..... HDMI®: PCM, Dolby TrueHD, Dolby Atmos,  
..... DTS-HD Master Audio, DTS:X, Line In/Out: PCM2.0,  
..... S/PDIF In/Out: Up to PCM5.1  
Max. Bandwidth ..... 10.2 Gbps  
Max. Pixel Clock ..... 297 MHz  
HDBaseT Transmission Distance ..... 1080P@60Hz 3D,  
..... 4K@60Hz 4:2:0, 4K@30Hz 4:4:2 ≤330ft (100m)  
..... VXP-T and VXP-R used as stand-alone extender set:  
..... 1080p@60Hz ≤492ft (150m)  
Control Method ..... RS232 Pass through, IR Pass through,  
..... Ethernet Pass through, Bi-Directional USB  
Dimensions WxHxD ..... 12.08" x 0.98" x 3.89" (306.8mm x 25mm x 98.8mm)  
Weight ..... 1.59 lbs (720g)

## Key Features

- Support for audio, video, power, Ethernet, RS-232 and IR pass-through over HDBaseT.
  - Signal transmission up to 90m/300ft for 4K and 100m/330ft for 1080p via a Cat-5e cable, and up to 100m/330ft for 4K and 1080p via a single Cat-6/6a/7 cable.
  - Supports resolution up to 4K@60Hz 4:2:0 8bit and HDCP 2.2 when installed with VXP-T Transmitter.\*
  - Analog stereo audio pass-through over HDBT.
  - S/PDIF digital audio pass-through over HDBT.
  - USB Host and Device ports with bi-directional USB pass-through for shared KVM control.
  - Built-in 10/100Mb Ethernet Switch.
  - One-way PoH (Power over HDBaseT) powers the VXP-R from the VXP-82 All-in-One Presentation Switcher or VXP-T Transmitter.
  - Phoenix port for additional power connection.
  - Support for standard and locking DC power plugs.
  - VXP-T and VXP-R are sold separately
- \* Note: Maximum resolution is 4K@30Hz when VXP-T is installed with VXP-82 All-in-One Presentation Switch.

# VMS-741 4K MultiViewer



Front View



Rear View

Part #: 10-210665-21

Included in the Box:

VMS-741, power cable (1), rack mount ears (2) with screws

## Specifications

AC Input Voltage.....100VAC ~ 240VAC, 15 Watts  
 Mounting..... Rack mount, 1 RU or free standing  
 Digital Video Input .....Four HDMI®/MHL, One Display Port  
 HDBaseT™ Input .....One RJ45  
 Analog Video Input ..... One VGA, Female 15-pin  
 ..... (VGA, YPbPr, Composite Video)  
 Video Output ..... One HDMI®  
 Output Resolution Range..... Up to 4K@30Hz  
 Compliance..... HDMI® 1.4, HDCP 1.4  
 Audio Line Input.....Seven, Analog Stereo (3.5mm jack)  
 Audio Input Impedance..... 20kOhms  
 Audio Output..... Embedded, HDMI®, Digital Optical Audio, TOSLINK  
 ..... 8 Channel (7.1 Surround) Analog Audio, 4 x 3.5mm Stereo Jack  
 Frequency Response ..... 20Hz to 20KHz  
 Front Panel Control ..... 17 Buttons for Input Select and Menu  
 RS-232..... One, Bi-directional (9-pin D-sub connector)  
 Ethernet Port .....One, 10/100Base-T (RJ45)  
 Dimensions WxHxD..... 17.28" x 1.73" x 11" (439 x 44 x 279mm)  
 Weight .....7.27 lbs (3.5kg)

The VMS-741 4K MultiViewer is designed for meeting spaces, auditoriums, sports bars and other installations requiring a wide range of video sources with differing resolutions and formats. To meet the unique challenges of these environments, the unit combines AV switching with advanced scaling to display content from up to seven sources including HDMI®, DisplayPort, VGA and an HDBaseT input.

The powerful multiviewer function allows up to four video sources to be displayed simultaneously on one display, with user selectable window layout combinations. The innovative VMS-741 also offers audio embedding and de-embedded audio outputs.

## Key Features

- Multiviewer function allows up to 4 sources to be viewed simultaneously via 16 preset window layouts.
- Built-in 4K scaler with up-scaling and down-scaling support.
- Provides signal switching of up to 7 video sources (4 HDMI, 1 Display Port, 1 HDBaseT, 1 VGA).
- HDMI 1.4 and is HDCP 1.4 compliant.
- Supports multiple output resolutions up to 3840 x 2160 @ 30Hz.
- Audio embedding via analog stereo inputs.
- 8-channel (7.1) analog audio and TOSLINK optical audio outputs.
- Supports up to 16 different preset window layouts.
- Auto-scaling, auto-detect EDID.
- Control via front panel buttons, RS-232, Ethernet or Web GUI.
- USB port for firmware updates.
- 1RU rack mountable.

## Example Schematic

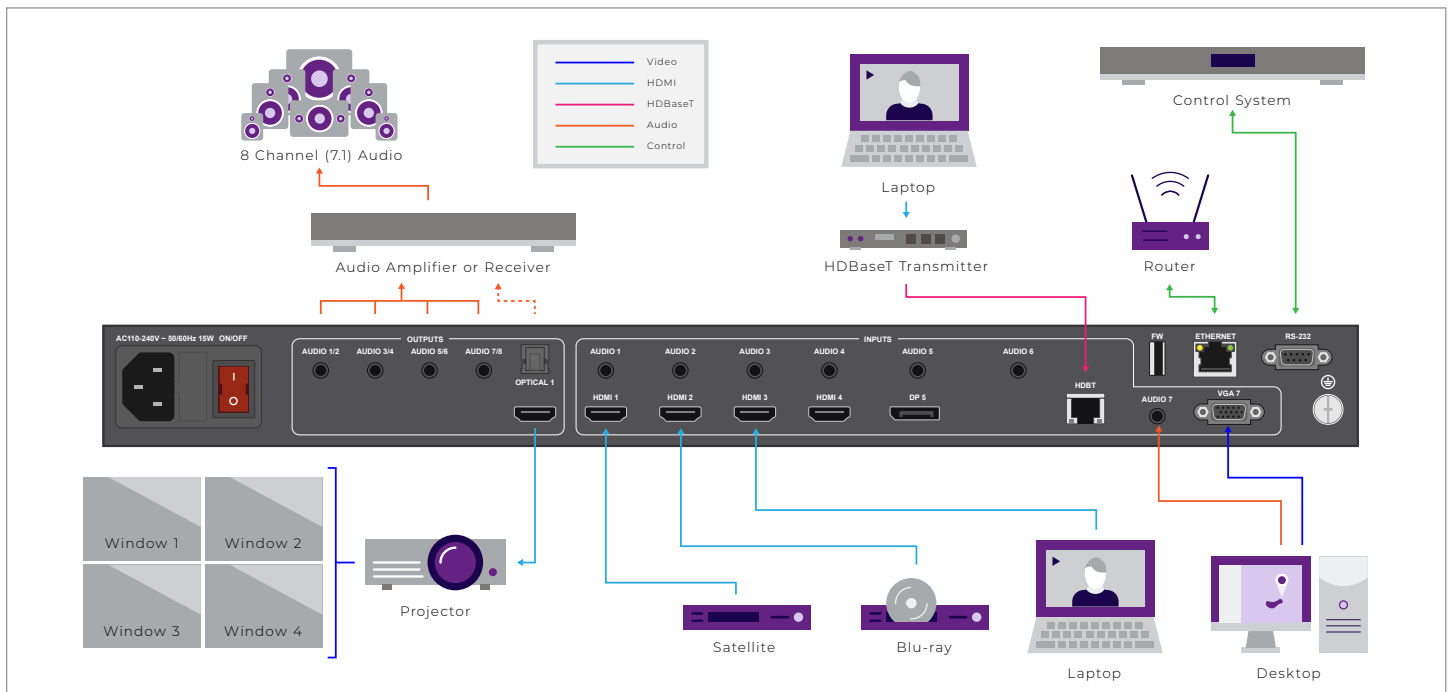

## CM-232 RS-232 Communication Module



Part#: 20-210017-13

The CM-232 communication module provides an RS-232 interface to almost any RS-232 enabled device. It attaches to supported RTI control processors on one end, and a device's DB-9 serial port connector on the other end. The CM-232 is capable of one-way transmission (no receive function is supported) of user-defined character or binary strings.

### Key Features

- Connects to the MPIO ports of RTI control processors (ex. XP-6s, XP-8v etc) and expansion modules (ex. PCM-4).
- Offers one-way RS-232 communication with nearly any RS-232 enabled device.
- Software-selectable baud rate up to 115.2K
- Industry-standard DB-9 male connector.
- No power supply required. Power is supplied by the output ports.
- User-definable output strings using Integration Designer® software.

### Specifications

Baud Rate .....	Up to 115.2K. Software Selectable
.....(Depends on attached control system)	
Cable Length .....	12 Feet (3.7 m)
Connector .....	DB-9 Male
Pins Used .....	GND, TXD, DTR (tied high)
Dimensions (W x H x D) .....	1.3" x 0.5" x 2" / 33 x 14 x 51mm

## CPB-1 Control Port Connecting Block



Part #: 10-210195-19

**Included in the Box:**  
CPB-1, power supply (12V, 1A), RJ45 to DB9 serial adapter

The CPB-1 Control Port Connecting Block provides a cost effective solution for installations such as classrooms or boardrooms that require a wired user interface and both infrared and RS-232 control of local devices. The CPB-1 provides power to one RTI wired user interface and has two output ports that allow the connection of up to two single or dual infrared emitters. It also incorporates an RS-232 port for control of devices without the need of an RTI processor.

### Key Features

- Provides power for one compatible RTI wired user interface.
- RJ45 - DB9 adapter included.
- Two infrared emitter outputs.
- Variable IR output power.
- Allows RTI wired user interfaces to communicate via one-way RS-232 to devices without a processor.
- 12VDC power supply included.

### Specifications

Power Supply .....	+12VDC, 1A
Number of IR Output Ports.....	Two
Output Ports .....	3.5mm jacks. Works with industry-standard IR emitters.
IR Output Drive .....	100mA maximum (per port, adjustable)
Infrared Input.....	Compatible with industry-standard repeaters and receivers
RS-232 Port.....	RJ45 Connection. Includes RJ45 to DB9 adapter
Mounting .....	Wall-mount or free standing
Dimensions (W x H x D) .....	4.0" x 3.5" x 1.1" / 102 x 89 x 28mm
Weight .....	8.4 oz. (238g)

## ESC-2+ Ethernet to Serial Converter



Part #: 10-210554-18

**Included in the Box:**  
ESC-2+, power supply (5V, 2A), RJ45 to DB9 serial adapters (2), screws & drywall anchors (2).

The ESC-2+ Ethernet to Serial Converter provides a convenient way to add two RS-232 ports to an RTI XP series control processor. Wire the ESC-2+ to the local Ethernet network with standard cat-5 cable and it will offer full two-way control, as if the device was wired directly to the control processor. Two RJ45 jacks provide efficient cat-5 cabling between the ESC-2+ and the device being controlled.

### Key Features

- Provides two additional serial ports to an RTI control processor.
- Use multiple ESC-2+ modules for virtually unlimited control of serial devices.
- Integrates seamlessly into Integration Designer.
- Can be discovered and configured by Integration Designer over Ethernet.
- Easy wiring to devices using cat-5 cable - Includes two RJ45 to serial adapters.
- A reset button allows the unit to be set back to default settings.

### Specifications

Power Supply .....	+5VDC, 1A
Serial (RS-232) Ports.....	Two, RJ45
.....	Includes two RJ45 to DB9 adapters
Ethernet Port.....	One, RJ45, 10/100 Base-T
Enclosure .....	ABS plastic
Mounting .....	Wall-mount or free standing
Dimensions (W x H x D) .....	With Tabs 2.8" x 1.8" x 1.0" / 71 x 45 x 25mm
Weight .....	1.7 oz. (50g)



## PCM-4 Ethernet Port Control Module



Part#: 10-210493-20  
 Included in the Box:  
 PCM-4, power supply  
 (12V, 1A), USB cable  
 (USB-A to micro-B)



### Specifications

Power Supply ..... +12VDC, 1A  
 Multi-Purpose Output Ports ..... Four custom 3.5mm 4-conductor jacks  
 ..... Designed for RTI modules as well as industry-standard IR emitters  
 IR Output Drive ..... 100mA maximum (per port, adjustable)  
 Infrared Frequency Transmission Range..... 15kHz - 460kHz  
 Infrared Input..... Compatible with industry-standard repeaters and receivers  
 Ethernet Port..... One, RJ45, 10/100 Base-T with Power-over-Ethernet  
 Trigger Output ..... One, 12 VDC, 100mA max  
 USB Port..... One, Programming  
 Enclosure..... Formed steel, black powder coating  
 Mounting ..... Wall-mount or free standing  
 Dimensions (W x H x D)..... 6.8in (173mm) x 2.9in (74mm) x 1.2in (31mm)  
 Weight ..... 14.3oz (406g)

With four multi-purpose I/O ports and a voltage trigger output (12VDC), the PCM-4 expands the output capabilities of an RTI XP series control processor to accommodate larger projects. Built-in Ethernet (with PoE) allows for convenient control over the local area network (LAN). Each MPIO port provides IR routing capabilities, one-way RS-232 communication\* and power sensing.\*

\* With RTI accessory devices.

### Key Features

- Four multi-purpose I/O ports made available to an RTI XP series control processor.
- Use multiple PCM-4 modules for virtually unlimited control of devices.
- Communication with XP processor over Ethernet network (LAN).
- Powered using power supply or class2 PoE (Power over Ethernet).
- Variable IR output power.
- 12VDC voltage trigger output.

## RCM-4 Ethernet Relay Control Module



Part #: 10-210480-16  
 Included in the Box:  
 RCM-4, power supply  
 (12V, 1A), terminal  
 connectors (4), USB  
 cable (USB-A to  
 micro-B)



### Specifications

Power Supply ..... +12VDC, 1A  
 Infrared Input..... Compatible with industry-standard repeaters and receivers  
 Relays ..... Four, capable of switching up to 28VDC@5A  
 Ethernet Port..... One, RJ45, 10/100 Base-T with Power-over-Ethernet  
 USB Port..... One, Programming  
 Mounting ..... Wall-mount or free standing  
 Dimensions (W x H x D)..... 6.8in(173mm) x 2.9in(74mm) x 1.2in(31mm)  
 Weight ..... 1.0 lb. (466g)

The RCM-4 is equipped with four individually addressable relays. Built-in Ethernet enables the convenience of control from an RTI XP series control processor via the LAN. An IR input allows the RCM-4 to be triggered from many different sources, including RTI wired user interfaces, control processors or third-party infrared repeater systems. Commands trigger open and close functions as well as adjustable hold times for momentary relay operation. The RCM-4 can be powered from the included power supply or PoE.

### Key Features

- Four individually addressable relays.
- Relays capable of switching up to 28VDC@5A.
- Relays can be used in a normally open or normally closed configuration.
- Relays can be controlled with both IR and Ethernet.
- Powered using power supply or class2 PoE (Power over Ethernet).

## VPS-1 Voltage Sensor Module



Part #: 20-210015-11

### Specifications

Output..... Compatible with industry standard IR emitters  
 IR Output Drive ..... 100mA maximum  
 Input Requirements..... 3V to 24VDC -or- 9V to 30V P-P AC (50Hz min)  
 Maximum Current Consumption..... 0.5mA  
 Control Cable Length ..... 12 feet (3.7 m)  
 Voltage Sensor Cable Length..... 3 feet (.9 m)  
 Dimensions (W x H x D)..... 1.75" (44mm) x 3.0" (76mm) x 0.7" (18mm)

The VPS-1 Voltage Power Sensor monitors the on and off status of almost any electronic component and provides this power status information to RTI control systems such as the XP-6s control processor. When the attached component is powered on, the VPS-1 detects the voltage supplied from the component, an attached power supply, or a third-party power sensor, and sends a signal to the RTI control system.

### Key Features

- Connects to the MPIO ports of RTI control processors (ex. XP-6s, XP-8v etc) and expansion modules (ex. PCM-4).
- Detects the on/off status of almost any component.
- No power supply required - Power is supplied by the output ports.
- Power sensing circuit is housed in a compact, rugged ABS enclosure.
- LED light indicates the current power status.
- Control cable can be extended up to 500 feet.

## ECB-5 IR Emitter Connecting Block



Part#: 10-210076-17

The ECB-5 IR Emitter Connecting Block provides expanded infrared signal distribution when used with RTI control processors, wired user interfaces, third party infrared repeater systems, etc. It has one infrared signal input and five emitter output ports that allow the connection of up to five single or dual infrared emitters.

### Key Features

- Five infrared emitter outputs.
- Incorporates a sense input for monitoring the power status of a switched outlet, current sensor, light sensor, etc.
- Variable IR output power.
- Steel construction.
- No power supply required for operation.

### Specifications

Power Supply (not included).....	+9VDC to +16VDC, 1.5A
Number of Output Ports .....	Five
Output Ports .....	3.5mm jacks
.....	Works with industry-standard IR emitters.
IR Output Drive .....	100mA maximum (per port, adjustable)
Infrared Input.....	Compatible with industry-standard repeaters and receivers
Mounting .....	Wall-mount or free standing
Dimensions (W x H x D) .....	2.6" (66mm) x 2.4" (61mm) x .9" (23mm)
Weight .....	4 oz. (108g)

## IPE-4 IR Port Expander



Part #: 10-210479-24  
**Included in the Box:**  
 IPE-4, mini jack cable (3ft), screws & drywall anchors (4)

The IPE-4 IR Port Expander provides convenient infrared signal expansion when used with RTI control processors. It has one 3.5mm infrared signal input jack and four IR emitter output ports that allow the connection of up to four single or dual infrared emitters. No additional power supply is required.

### Key Features

- Allows easy expansion of up to four emitters to a control processor IR port.
- Compatible with most industry standard single or dual IR emitters.
- Sturdy steel construction.
- A power supply is not required for the IPE-4 to function.
- A 3'(1m) mono cable with 3.5mm mini-plugs is included for easy connection to RTI processors.

### Specifications

Number of Output Ports .....	Four
Output Ports .....	3.5mm jacks
.....	Works with industry-standard IR emitters.
IR Output Drive .....	100mA maximum (per port)
Infrared Input.....	3.5mm jack
.....	Compatible with RTI processors, industry-standard repeaters and receivers
Mounting .....	Wall-mount or free standing
Dimensions (W x H x D).....	With tabs 5.1"(130mm) x 1.9"(48mm) x .9"(23mm)
Weight .....	6.8 oz. (192g)

## vIRsa Mouse IR Emitter



Part #: 10-210268-20  
**Included in the Box:**  
 vIRsa Mouse, tie wrap, clear holder, dark red holder

Designed with the professional integrator in mind, the "versatile" vIRsa Mouse is an IR emitter built to outperform all others. It is loaded with features to make installations go smoother, such as an unobtrusive, low-profile design, a flexible film adhesive and a separate holder that allows easy removal/replacement of the emitter. vIRsa Mouse is engineered with an actual (translucent) PCB to improve the integrity of electrical connections, a built-in resistor protects against over-driving and precision molding ensures consistent quality.

### Key Features

- Sleek, low-profile and symmetrical design.
- Separate holder allows for easy removal and replacement of emitter.
- Includes two emitter holders (one red, one clear).
- Blue LED flasher can be visible or covered.
- 10' cable reaches the entire rack - includes cable management strap.
- Flexible film adhesive conforms to curved surfaces.
- Translucent circuit board.
- Industry standard 3.5mm mini-plug uses precision over-molding.

### Specifications

Output.....	Compatible with industry standard IR repeater systems
Infrared Power Requirements.....	12VDC, 100mA maximum
Maximum Current Consumption.....	30mA
Cable Length .....	10 feet (3.0 m)
Plug type .....	3.5mm
Dimensions (W x H x D) .....	0.4" (10mm) x 0.5" (13mm) x 0.1" (2.5mm)

## ZM-24 Zigbee® Transceiver Module



**Part#:** 10-210178-20  
**Included in the Box:**  
 ZM-24, power supply (12V, 1A), Installation bracket, drywall screws/anchors (2), antenna, CAT5e RJ45 cable (6ft)

The ZM-24 2.4GHz Zigbee® Transceiver Module provides bi-directional communication between two-way enabled RTI remote controls and control processors utilizing Zigbee® wireless communication. Capable of being hard-wired directly to a control processor or be used as a wireless repeater device to create an ultra-reliable, self-healing Zigbee® network. The ZM-24 does not directly control A/V components. It must be used in conjunction with a Zigbee® enabled processor.

### Specifications

Power ..... +9VDC to +16VDC, 60mA  
 RTI Com Port ..... Two-way Zigbee® Communication Port, RJ45 Connection  
 ..... Drives up to 1000 ft (300 m) of wire  
 Wireless Networking ..... IEEE802.15.4 Zigbee® network compliant  
 RF Frequency Range ..... 2.4Ghz - 2.5Ghz  
 Communications ..... OTA (Over-the-air) Programmable  
 Enclosure ..... High-impact molded ABS plastic, black  
 Mounting ..... Detachable bracket  
 Dimensions -Ant. Flat (WxHxD) ..... 3.5" (89mm) x 4.0" (101mm) x 1.1" (28mm)  
 Dimensions -Ant. Ext. (WxHxD) .. 3.5" (89mm) x 7.25" (184mm) x 1.1" (28mm)  
 Weight ..... 4 oz (113g)

### Key Features

- Enables bi-directional wireless communication.
- Wireless communication range between ZM-24 modules up to 100 ft.
- Connects to a processor up to 1000 feet away via standard Cat-5 cable.
- Can be used in "coordinator" mode, or create a Zigbee network by adding modules configured in "repeater" mode.
- Utilizes IEEE802.15.4 wireless Zigbee® communication at 2.4Ghz.
- Easy mounting with adjustable antenna and detachable wall bracket.
- Powered by an RTI control processor or included power supply.

## ZW-9 Z-Wave® Interface Module (EU & AU Model only)



**Part #:**  
**EU Model:** 10-210552-16  
**AU Model:** 10-210553-17  
**Included in the Box:**  
 ZW-9, power supply (5V, 2A), mounting plate, screws & drywall anchors (2)

The ZW-9 Z-Wave interface uses the Z-Wave wireless protocol to provide the communication link between RTI systems and lighting, door locks, thermostats, and other Z-Wave-enabled devices. Eliminating the need for a different app for each device, the ZW-9 combined with an RTI XP central processor provides users with unified control and monitoring over all devices directly on their RTI user interface.

### Specifications

Power Supply ..... +5VDC, 2A  
 RTI Communication ..... RJ45, Ethernet  
 Wireless Networking ..... Z-Wave Plus Network Compliant  
 RF Frequency Range ..... Varies by region  
 Enclosure ..... High-impact molded ABS plastic, black  
 Mounting ..... Detachable bracket  
 Dimensions (W x H x D) ..... 5.167" (131mm) x 4.0" (102mm) x 1.12" (28mm)  
 Weight ..... 4.1 oz. (116g)

### Key Features

- Wireless control and monitoring of Z-Wave devices via the RTI control system.
- Certified as a Z-Wave Plus product.
- Compatible with a broad range of Z-Wave certified electronics
- Expandable and scalable system allows control of more than 200 devices.
- Programmed using RTI Integration Designer software.
- Powered via PoE (Power over Ethernet) or included power supply.

## RM-433 RF Receiver



**Part #:** 10-210039-16  
**Included in the Box:**  
 RM-433, antenna, 3-conductor wire

The RM-433 is a radio frequency receiving device for communicating to RTI control systems and operates at 433MHz. The RM-433 contains a microprocessor that monitors all received signals so that RF noise is filtered out. When valid RF data from an RTI remote is detected, the RM-433 passes the signal through its output driver which allows the data to travel long distances over wire. The output driver is compatible with industry standard infrared repeating systems, and can be wired together with those systems or with additional RM-433 units.

### Specifications

Power Requirements ..... +9VDC to +16VDC @ 60mA  
 RF Carrier Frequency ..... 433.92 MHz  
 Output Drive ..... 200mA maximum  
 Module Dimensions (HxWxD) .. 3.5in (89mm) x 3.4in (86mm) x 1.0in (25mm)  
 Antenna Length ..... 13 in" (330mm)  
 Weight ..... 4.4 oz. (125 grams)

### Key Features

- Reliable RF reception due to matched antenna, connector, and PCB.
- Modular design that allows multiple RM-433 units to be wired together allowing for nearly any desired coverage area.
- Output signal is compatible with industry standard infrared repeating systems. This allows multiple IR and/or RF receivers to be wired together into an RTI control system.
- No dedicated power supply required. Power is derived directly from the RTI control system.
- A feedback LED confirms operation.

## CB-8 Connecting Block



**Part #: 10-210205-11**  
**Included in the Box:**  
 CB-8, power supply  
 (16V, 4.3A)

The CB-8 is an installation accessory designed to provide convenient and reliable power connections for up to eight (8) RTI in-wall keypads, touchpanels and other devices. In addition to providing power, the CB-8 combines and routes the infrared outputs from the touchpanels to a single output for connection to an RTI control processor. Multiple CB-8 units can be daisy-chained for connecting more than eight devices. A 4.3 Amp, 16VDC power supply is included.

### Specifications

Power .....	+16VDC, 4.3A
Maximum Current per Port .....	1.5A
Enclosure .....	Formed steel, black powder coating
Dimensions (H x W) .....	5.5 in (127mm) x 9.4 in (239mm)
Mounting .....	Wall-mount or free standing
Weight .....	12.6oz (359g)

### Key Features

- Includes 16VDC, 4.3 Amp power supply capable of powering up to eight RTI wired user interfaces.\*
- Multiple CB-8 units can be daisy-chained.
- Standard RJ45 ports for easy connection of touchpanels

## PS16-1 16VDC Power Supply



**Part #: 40-210285-22**

The PS16-1 is used to power a single in-wall touchpanel, when a connecting block (CB-8) is not used.

### Specifications

Power Supplied .....	+16 VDC, 1.6A, 25W
Dimensions (L x W x H) .....	3.7 in (94mm) x 2.2 in (56) x 1.3 in (34mm)
Weight .....	10.0oz (290g)

NOTE: Actual design/specs may vary.

## IST Power Supply



**Part #: 20-210403-12**  
**Included in the Box:**  
 power supply (1) with  
 US, EU, UK, AU plugs

The IST Power Supply is used to power either the IST-10 or IST-5 touchpanel when PoE is not used.

Note: The IST Power Supply is included in the IST Stand Kit

### Specifications

Power Supplied .....	+12VDC, 2A
Dimensions (W x H x D) .....	2.75 in (70mm) x 1.625 in (41) x 1.5 in (38mm)
Weight .....	5.7oz (161.6g)



## IR-PRO Professional Infrared Capture System



**Part#: 10-210043-11**  
**Included in the Box:**  
 IR-PRO, USB cable (male A to male B), USB cable (male A to mini B), USB cable (USB-A to micro-B), X version remote programming cable, Velcro straps (3), carrying/storage case

The IR-PRO is an infrared code capture system that is specifically designed for system integration professionals.

Unlike the capture hardware available in universal “learning” remote controls, the IR-PRO incorporates a much more robust and sophisticated circuit design. This, combined with RTI’s proprietary software algorithms, allows the IR-PRO to reliably capture almost any infrared code regardless of code format, frequency, output strength, battery condition, alignment position, location of infrared emitter, etc.

### Key Features

- Advanced infrared detection circuit ensures accurate code capture.
- Compatible with virtually all brands of AV equipment and remote controls.
- EMI noise suppression for glitch-free acquisition.
- USB port for programming and power.
- Available only to professional system integrators.

### Specifications

Power Requirements ..... Powered directly from USB port  
 IR Carrier Frequency Range ..... Up to 460 kHz  
 Operating Temperature ..... +32°F to +122°F (0°C to +50°C)  
 Operating Humidity ..... 5% to 95% non-condensing  
 Dimensions ..... 4.5" (114mm) x 2.8" (71mm) x 1.3" (33mm)  
 Weight ..... 6.0 oz (170 g)

## ZB-PRO Professional 2.4GHz Zigbee® Network Management Tool



**Part #: 10-210216-13**  
**Included in the Box:**  
 ZB-PRO, USB extension cable

The ZB-Pro is a Professional Network Management Tool for use with RTI 2.4GHz wireless ZigBee® networks. Attached to a standard USB port of a PC, the ZB-Pro communicates with ZM-24 Transceiver Modules via 2.4GHz RF during the setup process.

### Key Features

- Updates the firmware in the RTI ZM-24 Transceiver Module.
- Downloads network configuration data into a ZM-24.
- No external power supply is required. Power is derived directly from the USB port.
- Utilizes IEEE 802.15.4 wireless Zigbee® communication at 2.4Ghz.
- Feedback LEDs confirm various operations.
- Compact, rugged design.
- Available only to professional systems integrators

### Specifications

Power Requirements ..... Powered directly from USB port  
 RF Carrier Frequency ..... 2.4GHz (Zigbee® technology)  
 Standards ..... IEEE 802.15.4 (Zigbee® Wireless Mesh Networking)  
 Dimensions (HxWxD) ..... 4.28" (109mm) x 1.37" (35mm) x .65" (17mm)  
 Weight ..... 1.1 oz (32 g)

## ZW-PRO Z-Wave® Network Management Tool



**Part #: 10-210606-16**

The ZW-PRO is a Professional Network Management Tool for use with Z-Wave wireless networks. Attached to a standard USB port of a laptop computer, the ZW-PRO wirelessly communicates with Z-Wave enabled devices during the network inclusion setup process. Used in conjunction with the Z-Wave Manager configuration software, the ZW-PRO simplifies the Z-Wave network setup, by allowing the installer to roam the installation with a laptop as they move between device locations.

### Key Features

- Enables “inclusion” of devices onto Z-Wave wireless network.
- Plugs into a laptop USB port allowing the installer to roam to each device during Z-Wave network setup process.
- Designed to aid Z-Wave network setup for devices such as door locks and security devices with a short wireless range before “inclusion”.
- No external power supply is required. Power is derived directly from the USB port.
- Compact, rugged design.
- Available only to professional systems integrator.

### Specifications

Power Requirements ..... Powered directly from a PC USB port  
 Wireless Networking ..... Z-Wave Plus Network Compliant  
 RF Frequency Range ..... 908.4MHz (US Region)  
 ..... Varies by region  
 Dimensions (LxWxD) ..... 3.46" (88mm) x 1.1" (28mm) x .39" (10mm)  
 Weight ..... .5 oz (14 g)

## Programming Cable (for the T4x T2x, T3x, T2i)



Part #: 40-210767-27

USB cable for downloading program files to the T2i, T2x, T3x and T4x remote controls.

Connectors: USB type A to 10 pin RTI remote control connector.

Cable Length: 6.56 ft (2m).

The programming cable is also included with the IR-PRO Professional Infrared Capture System.

### Specifications

Connections .....	USB, PC USB Port
.....	10Pin Connector, Remote Control Charging Dock Port
Dimensions (L) .....	6.56 ft (2m)

### Key Features

- Cable used for downloading programming into the T2i, T2x, T3x and T4x remote controls.



Remote Technologies Incorporated  
5775 12th Avenue East, Suite 180  
Shakopee, MN 55379  
Tel: 952-253-3100  
[www.rticontrol.com](http://www.rticontrol.com)